

Automotive Components Distributors



www.bowersmidland.co.uk

Bus & Coach Products

H. Bowers

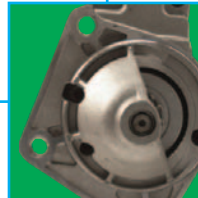
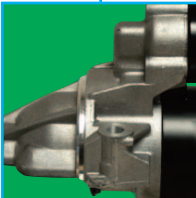
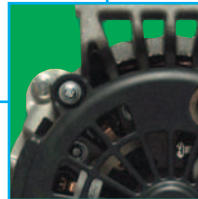
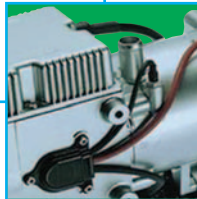
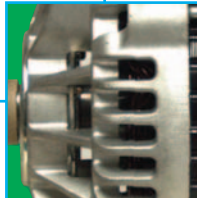
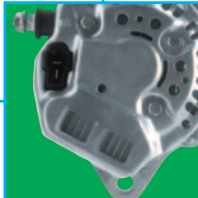
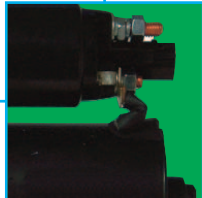
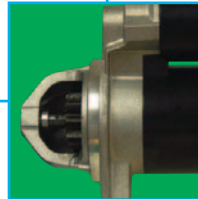

Bus & Coach Products

Issue 6.02

All products have been developed with our five key objectives firmly in mind and which we consider to be central to the success of our joint trading relationships.

1. We are committed to providing our customers with the highest levels of service.
2. We are committed to marketing and selling only the highest quality products.
3. We are committed to offering value for money.
4. We are committed to providing added value, service and support.
5. We are committed to consistent and continual improvement of our range and services, which allows us to remain that little bit unique in our market place.

It is our intention wherever possible to continue to add further references to the Five Star Product range and we will communicate these to you via our quarterly bulletins. I do hope that you will find H. Bowers Ltd fulfils your requirements.

Kind Regards



Jeff Savage
Managing Director of H. Bowers Limited

Quality Service Since 1939

H. Bowers Ltd Contacts

Switchboard Tel : 01782 599990

Sales Office Tel : 01782 590700 Fax : 01782 590712

Workshop Tel : 01782 590702 Fax : 01782 598516

Accounts Tel : 01782 599990

Marketing Tel : 01782 590707

Get Online...

Search For Our Social Network Pages

E-mail : sales@bowersmidland.co.uk

Web : www.bowersmidland.co.uk



Catalogue Information

Please Read

This catalogue has been divided into multiple coloured sections containing various groups of similar products. All products are listed in ascending part number order within their given section or sub-section. The list to the right shows a breakdown of each section for easy group reference.

Please check the H. Bowers website for the latest product releases.

Visit us at www.bowersmidland.co.uk.

Keeping you ahead of the game.

All sizes are millimeters (mm) unless stated.

Plug images and other markings/symbols are specific only to the part number they are listed with and do not necessarily relate to similar products. Always read the description.



Postal Address

H. Bowers Ltd

Normacot Road

Longton

Stoke-on-Trent

Staffordshire

United Kingdom

ST3 1PU

View an interactive map on our website

List Of Contents

Colour Coded Sections

S	Title	Page
1	Alternators	1.1
	<i>Bowers Outright</i>	1.1
	<i>Genuine Bosch</i>	1.5
	<i>Genuine Prestolite</i>	1.5
	<i>Battery Advert</i>	1.6
2	Starter Motors	2.1
	<i>Bowers Outright</i>	2.1
	<i>Genuine Prestolite</i>	2.2
	<i>Wiper Blade Advert</i>	2.4
3	Dynamos	3.1
	<i>All Dynamos</i>	3.1
4	Relays	4.1
	<i>All Relays</i>	4.1
5	Lighting Products	5.1
	<i>All Lighting</i>	5.1
6	Switches	6.1
	<i>Large Battery Isolator</i>	6.1
	<i>Standard Battery Isolator</i>	6.5
7	Heaters	7.1
	<i>Air Heaters</i>	7.1
	<i>Water Heaters</i>	7.2
8	Solenoids	8.1
	<i>All Solenoids</i>	8.1
9	Accessories	9.1
	<i>All Accessories</i>	9.1
W	Workshop Facility	W.i
	<i>Advertisement</i>	W.i

End of Contents

Alternators		Side View	Rear View	Notes / Applications
BAO3050				<i>Bosch type :</i> 3440, 3741, 4158, 4787.
24 V	55 A			Mercedes
INT REG				
BAO3078		 <i>Prestolite</i>		<i>Bosch type :</i> 3491, 3829, 3914.
24 V	140 A			Kassbohrer Setra, Mercedes Coach, Decker
INT REG				
BAO3102		 <i>Prestolite</i>		<i>Bosch type :</i> 3461.
24 V	140 A			Scania
INT REG				
BAO3103		 <i>Prestolite</i>		<i>Bosch type :</i> 3460, 3953, 4285, 4285.
24 V	140 A			MAN, Mercedes Benz, Van Hool, Volvo
INT REG				
BAO3146				<i>Bosch type :</i> 4314.
12 V	95 A			LDV Minibus, Ford Transit
INT REG				
BAO3171				<i>Bosch type :</i> 4018.
12 V	90 A			Mercedes Sprinter
INT REG				
BAO3241				<i>Bosch type :</i> 3777, 4026.
24 V	80 A			Mercedes 709
INT REG				
BAO3294		 <i>Letrika</i>		<i>Bosch type :</i> 3776.
24 V	80 A			Volvo
INT REG				
1.1		Order Hotline : 01782 590700		Bus & Coach

Sales Tel : 01782 590700

Sales Fax : 01782 590712

sales@bowersmidland.co.uk

www.bowersmidland.co.uk

Sales Tel : 01782 590700

Sales Fax : 01782 590712

sales@bowersmidland.co.uk

www.bowersmidland.co.uk

Notes / Applications	Side View	Rear View	Alternators	
Bosch type : 3437, 3384. Volvo B6			BAO3303	
			24 V	55 A
			INT REG	
Bosch type : 3949. Scania			BAO3314	
			24 V	80 A
			INT REG	
Bosch type : 4026, 3979, 4157. Mercedes			BAO3319	
			24 V	80 A
			INT REG	
Bosch type : 4239, 4237, 4240, 4529, 4538, 4810, 4811. Mercedes Atego			BAO3322	
			24 V	110 A
			INT REG	
Replacing NCB1 & NCB2 style units. Volkswagen, Volvo B7R			BAO3327	
			24 V	110 A
			INT REG	
Bosch type : 4550, 4657, 4656, 4549. DAF			BAO3346	
			24 V	110 A
			INT REG	
With clutch pulley. Bosch type : 4252, 4253, 4366, 4390. Mercedes			BAO3356	
			12 V	115 A
			INT REG	
Complete with pulley & adjuster kit. Dennis			BAO3382	
			24 V	95 A
			INT REG	
Bus & Coach	Sales Fax : 01782 590712		1.2	

Alternators		Side View	Rear View	Notes / Applications
BAO3383		 		Dennis
24 V	95 A			
INT REG				
BAO3412		 		<i>Bosch type : 4406</i>
24 V	140 A			
INT REG				
BAX1141020				<i>Bosch type : 4153, 4253.</i>
12 V	90 A			
INT REG				
BAX1341002				<i>AC203R type.</i>
24 V	115 A			
BAX1341005				<i>AC7 type.</i>
24 V	60 A			
BAX1341006				<i>AC7 type.</i>
24 V	60 A			
BAX1341007				<i>AC172RA type.</i>
24 V	140 A			
BAX1341009				<i>AC203 type.</i>
24 V				
1.3		Order Hotline : 01782 590700		Bus & Coach

Sales Tel : 01782 590700

Sales Fax : 01782 590712

sales@bowersmidland.co.uk

www.bowersmidland.co.uk



Sales Tel : 01782 590700

Sales Fax : 01782 590712

sales@bowersmidland.co.uk

www.bowersmidland.co.uk

Notes / Applications	Side View	Rear View	Alternators	
Scania			BAX2341003	
Gardner 6LXB Engine. Cradle mounted. Bristol BLMC	 <i>Prestolite</i>		BAX2841007	
AC203R type. Cradle mounted. Dennis, Volvo	 <i>Prestolite</i>		BAX2841010	
Cradle mounted. Leyland Lynx, Volvo Olympian	 <i>Prestolite</i>		BAX2841013	
Leyland Olympian 6LXB	 <i>Prestolite</i>		BAX2841014	
Twin lug. Volvo B10	 <i>Prestolite</i>		BAX2841015	
Dennis, Leyland, Volvo	 <i>Prestolite</i>		BAX2841016	
Dennis Dart, Optare Metrorider 1990 - '96 & 1996 - Onwards	 <i>Prestolite</i>		BAX2841018	
Bus & Coach	Sales Fax : 01782 590712		1.4	

Alternators		Side View	Rear View	Notes / Applications
BAX2841019		 Prestolite		Renault Tracer
24 V	180 A			
INT REG				
BAX2841023				Dennis Dart
24 V	60 A			
BOS3979		 BOSCH		<i>Bosch type : 3777, 4026.</i> DAF, Mercedes
24 V	80 A			
BOS4239		 BOSCH		<i>Can use BAO3322.</i> <i>Bosch type :</i> 4239, 4237, 4240, 4529, 4538, 4810, 4811. Mercedes Atego
24 V	110 A			
BOS4240		 BOSCH		<i>Can use BAO3322.</i> <i>Bosch type :</i> 4239, 4237, 4240, 4529, 4538, 4810, 4811. Mercedes Atego
24 V	110 A			
PREMDA3920		 Prestolite		<i>Can use BAO3050.</i> <i>Bosch type :</i> 3440, 3741, 4158, 4787. Mercedes
24 V	55 A			
INT REG				
PREZ1277680		 Prestolite		<i>Bosch type : 4599, 3461.</i> Scania L94 L113CRL, Renault, Volvo
24 V	140 A			
INT REG				
PREZ1277720		 Prestolite		<i>Can use BAO3103.</i> <i>Bosch type :</i> 3460, 3953, 4285, 4285. MAN, Mercedes Benz, Van Hool, Volvo
24 V	140 A			
1.5		Order Hotline : 01782 590700		Bus & Coach

Sales Tel : 01782 590700

Sales Fax : 01782 590712

sales@bowersmidland.co.uk

www.bowersmidland.co.uk

Sales Tel : 01782 590700

Sales Fax : 01782 590712

sales@bowersmidland.co.uk

www.bowersmidland.co.uk

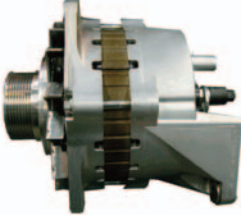
Notes / Applications	Side View	Rear View	Alternators	
Volvo B7			BAX2341004	
			24 V	100 A
			INT REG	
Scania Bus & Truck...			BAX2341005	
...			24 V	150A
...			INT REG	
...				
...				
...				
...				
...				
...				
...				
...				
...				
Bus & Coach	Sales Fax : 01782 590712		1.6	

BAO

12 V

INT REG

WE SUPPLY BATTERIES

Full ranges of Banner & Yuasa Batteries



Batteries to suit All Engines

In need of a new battery? Tell our sales team your requirements and let us provide you with a leading Yuasa or Banner replacement.

Large and small batteries covered

Full battery ranges available

Proven Brands

-

Try Us Out



Please ring our sales team for more information

01782 590700

Starter Motors			Side View	Front View	Notes / Applications	Starter Motors	
BSO7039					LDV Minibus, Ford Transit	BSO	
12 V	2.3 KW						2.0 KW
13 Tooth	Clockwise						Clockwise
BSO7053			 Letrika		Mercedes 709, Mercedes Minibus		
24 V	4.0 KW						
9 Tooth	Clockwise						
BSO7081			 Prestolite		Volvo B6		
24 V	4.0 KW						
9 Tooth	Clockwise						
BSO7085			 Letrika		Scania Irizar, Scania L94		
24 V	4.0 KW						
9 Tooth	Clockwise						
BSO7098			 Prestolite		Renault FRI, Renault Tracer, Renault R13-12, Renault P100-180		
24 V	6.6 KW						
12 Tooth	Clockwise						
BSO7102			 Prestolite		Volvo B10		
24 V	6.5 KW						
11 Tooth	Clockwise						
BSO7103			 Prestolite		Scania L112 CRL		
24 V	6.6 KW						
11 Tooth	Clockwise						
BSO7106					Volvo Olympian		
24 V	5.5 KW						
11 Tooth	Clockwise						
2.1			Order Hotline : 01782 590700		Bus & Coach	2.1	

Starter Motors	Notes / Applications	Side View	Front View	Starter Motors	
12 V 11 Tooth	Kassbohrer Setra, MAN, Mercedes Coach / Decker	 		BSO7108	
				24 V	5.5 KW
				9 Tooth	Clockwise
	Mercedes Sprinter, Mercedes Vito			BSO7265	
				12 V	2.0 KW
				10 Tooth	Clockwise
	Optare Delta	 		BSO7278	
				24 V	5.4 KW
				11 Tooth	Clockwise
	M95R Series. Dennis	 		BSO7390	
				24 V	5.0 KW
				10 Teeth	Clockwise
	Helper Solenoid On Bottom. Mercedes Optare	 		BOS1724	
				24 V	4.0 KW
				9 Teeth	Clockwise
	Gardner Engine. Leyland Fleetline, Olympian, MCW Metrobus	 		CAVU624B-3	
				24 V	
				13 Teeth	Clockwise
	Gardner 6LXB Engine. Bristol BLMC, Leyland Olympian 6LXB	 		CAVU624B-13	
				24 V	
				12 Teeth	Clockwise
	Dennis Javelin, Optare Bova Futura	 		PRE1327A581	
				24 V	7.8 KW
				12 Teeth	Clockwise
2.2	Bus & Coach	Sales Fax : 01782 590712		2.2	

BSO

12 V

11 Tooth

BOSCH WIPER BLADES

Quality Products In Stock

High Quality Bosch Wiper Blades

The internal tension strip keeps constant pressure across the blade as the screen curves. A high quality rubber spine enables effective flipover functions. Precision cut cleaning edge ensures smear free wiping. Pre-mounted quick clip adapters makes fitting the blade a quick & simple process.

Economy range wiper blades are also available

Available sizes range from :

11" to 26"

-

Try Us Out



BOSCH



Economy Wiper Blades

Economy range wiper blades are also available
Available sizes range from 11" to 26"



Please ring our sales team for more information

01782 590700

Dynamos		Side View	Front View	Notes / Applications	Dynamos
D45				... SERVICE EXCHANGE PART ** OLD CORE REQUIRED **	BSO
12 V					2.0 KW
	Clockwise				Clockwise
G7				... SERVICE EXCHANGE PART ** OLD CORE REQUIRED **	
24 V					
GL4512-11M				<i>Bracket Mount.</i> Des Number : 1108801 SERVICE EXCHANGE PART ** OLD CORE REQUIRED **	
12 V					
	Clockwise				
GL4524-2				<i>Cradle Mount.</i> Des Number : 1108520 SERVICE EXCHANGE PART ** OLD CORE REQUIRED **	
24 V					
	Clockwise				
GL4524-25				<i>Bracket Mount.</i> Des Number : 1109010 SERVICE EXCHANGE PART ** OLD CORE REQUIRED **	
24 V					
	Clockwise				
H55				... SERVICE EXCHANGE PART ** OLD CORE REQUIRED **	
12 V					
	Clockwise				
DO7X				<i>Split field unit.</i> SERVICE EXCHANGE PART ** OLD CORE REQUIRED **	
24 V					
3.1		Order Hotline : 01782 590700		Bus & Coach	3.1

BSO

12 V

11 Tooth

Rotating Electrics

H. Bowers Product Catalogue

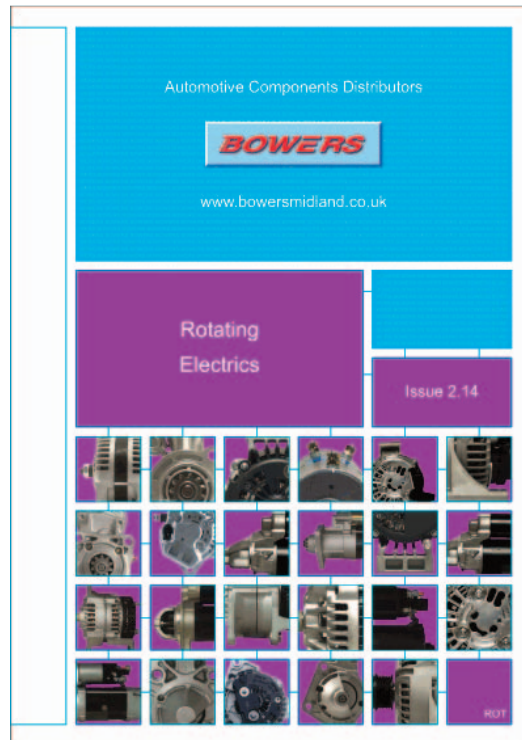

Rotating Electrics Catalogue

Looking to source a unit?

We have over 800 Part Numbers

Alternators - Starter Motors - DC Motors - Dynamos

Outright & Exchange Units

Our range is ever growing so keep up to date

Don't get left behind!

Ask our sales staff for more information

Relays	Part Number	Description	Relays
	1805734	CAV Contactor Repeater Relay/Control Box. Type 381-4A. Despatch Number : 1805734. ** SERVICE EXCHANGE PART, OLD CORE REQUIRED **	
	37ET-32XX	CAV Control board For G5524B-2X Dynamo. 12 Cell Acid or 18 Cell Nife. Capacity 50-160 A.H. Max lamp load 16 amps at 24 volts. ** SERVICE EXCHANGE PART, OLD CORE REQUIRED **	
	37F-4M	CAV Control board For D07X24 Low Speed Dynamo. Use only with battery. 18 Cell Acid or 18 Cell Nife. Capacity 60-220 A.H. Max lamp load 25 amps at 24 volts. ** SERVICE EXCHANGE PART, OLD CORE REQUIRED **	
	CAV Type 460	CAV Control board Type 460 control board incorporating 440 regulator. The regulator will be damaged by wrong connections or short circuited terminals. Do not use MEGGER type tester. Max ambient temperature 70°C. ** SERVICE EXCHANGE PART, OLD CORE REQUIRED **	
	BTS-2	Simms Control board ... ** SERVICE EXCHANGE PART, OLD CORE REQUIRED **	
	EG 12-2	24V Simms Regulator ... ** SERVICE EXCHANGE PART, OLD CORE REQUIRED **	
	EM-44-1	24V Simms Regulator Recommended load 30 Amps. ** SERVICE EXCHANGE PART, OLD CORE REQUIRED **	
	FS 12-1	24V Simms Control Board ... ** SERVICE EXCHANGE PART, OLD CORE REQUIRED **	
4.1	Tel : 01782 590700	Bus & Coach Products Catalogue	4.1

Relays	Description	Part Number	Relays
	<p>CAV Current Voltage Regulator Positive Return. 24V. 15Amp.</p> <p>** SERVICE EXCHANGE PART, OLD CORE REQUIRED **</p>	37453	
	<p>CAV Current Voltage Regulator Negative Return. 24V. 15Amp.</p> <p>** SERVICE EXCHANGE PART, OLD CORE REQUIRED **</p>	37454	
	<p>CAV Current Voltage Regulator Positive Return. 24V. 14Amp.</p> <p>** SERVICE EXCHANGE PART, OLD CORE REQUIRED **</p>	37511	
	<p>CAV Control board For H5512 Normal Speed Dynamo. Use only with battery. 6 Cell Acid or 9 Cell Nife. Capacity 75-200 A.H. Max lamp load 20 amps at 12 volts. Despatch Number : 1686471</p> <p>** SERVICE EXCHANGE PART, OLD CORE REQUIRED **</p>	189-47MB	
	<p>CAV Control board For DO7X24 Normal Speed Dynamo. Use only with battery. 12 Cell Acid or 18 Cell Nife. Capacity 60-220 A.H. Max lamp load 30 amps. Despatch Number : 1686770</p> <p>** SERVICE EXCHANGE PART, OLD CORE REQUIRED **</p>	189A-7	
	<p>CAV Control board Dynamo H5512 Ventilated Type. Battery 6 Cell Acid Or 9 Cell Nife. Capacity 75-200 A.H. Max lamp load 30 amps at 12 volts. Despatch Number : 1687500</p> <p>** SERVICE EXCHANGE PART, OLD CORE REQUIRED **</p>	202B/35	
	<p>CAV Control board Dynamo H5512/51 Ventilated Type. Battery 6 Cell Acid Or 9 Cell Nife. Capacity 75-150 A.H. Max lamp load 45 amps at 12 volts. Despatch Number : 1687351</p> <p>** SERVICE EXCHANGE PART, OLD CORE REQUIRED **</p>	202B/50	
	<p>CAV Control board Dynamo H5524 H.5. Ventilated Type. Battery 12 Cell Acid Or 18 Cell Nife. Capacity 75-150 A.H. Max lamp load 25 amps at 24 volts. Despatch Number : 1687550, Serial Number : WK-242</p> <p>** SERVICE EXCHANGE PART, OLD CORE REQUIRED **</p>	202B/55	
4.2	Bus & Coach Products Catalogue	Fax : 01782 590712	4.2

Lighting Products

H. Bowers Product Catalogue



Rotating Electrics Catalogue

Need to replace a lamp? Looking to upgrade to LED?

We have hundreds of part numbers

Rear Lamps - Interior Lighting - Markers - Worklamps

LED & Bulb Type Available

Our range is ever growing so keep up to date

Don't get left behind!

Ask our sales staff for more information



DO YOU OWN A TRUE CLASSIC?

Look after your pride and joy with our classic tractor, truck & bus service and repair facility. Our fully trained workshop technicians can repair most starter motors, alternators and dynamos giving your old classic a new lease of life.

Outright units for classic vehicles can be very hard to find. Our workshop facility can help. We will repair your faulty unit, which is often considerably more cost effective than buying a replacement part outright.









FOR MORE INFORMATION















Please contact us using the following methods















Service Reception Telephone
01782 590702

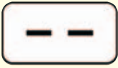





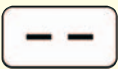

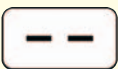







Service Reception Fax
01782 598516









H. Bowers Ltd Email
sales@bowersmidland.co.uk



Lighting Products	Part No.	Part Description	Additional	Lighting Products
	9986038	LED Interior Strip Lamp > Universal Applications FiveStar products universal 24v LED interior strip lamp module. 2.2 Watt output with 24 LED's. Designed to be intergrated into vehicle bodywork. 2 Wire connection : Red = Positive, Black = Negative. - - Overall Dimensions : 500mm (L) x 18mm (H) x 11mm (D) On/Off Switch No	2 Wire Connection No Plugs LED	
	9986043	LED Interior Strip Lamp > Universal Applications FiveStar Products universal 12v LED interior strip lamp module. 2.2 Watt output with 24 LED's. Designed to be intergrated into vehicle bodywork. 2 Wire connection : Red = Positive, Black = Negative. - - Overall Dimensions : 500mm (L) x 18mm (H) x 11mm (D) On/Off Switch No	2 Wire Connection No Plugs LED	
	9986046	LED Interior Strip Lamp > Universal Applications FiveStar Products universal 12v LED interior strip lamp module. 2.2 Watt output with 24 LED's. Mounted in a low profile aluminium housing. 2 Wire connection : Red = Positive, Black = Negative. On/Off switch. 'On' mounted on the front of the lamp. - - Overall Dimensions : 626mm (L) x 44mm (H) x 15mm (D) On/Off Switch Yes	2 Wire Connection No Plugs LED	
	9986047	LED Interior Strip Lamp > Universal Applications FiveStar Products universal 24v LED interior strip lamp module. 2.2 Watt output with 24 LED's. Mounted in a low profile aluminium housing. 2 Wire connection : Red = Positive, Black = Negative. On/Off switch. 'On' mounted on the front of the lamp. - - Overall Dimensions : 626mm (L) x 44mm (H) x 15mm (D) On/Off Switch Yes	2 Wire Connection No Plugs LED	
	9986048	LED Interior Strip Lamp > Universal Applications FiveStar Products universal 12v LED interior strip lamp module. 2.2 Watt output with 24 LED's. Mounted in a low profile aluminium housing. 2 Wire connection : Red = Positive, Black = Negative. On/Off switch. 'On' mounted on the front of the lamp. - - Overall Dimensions : 1106mm (L) x 44mm (H) x 15mm (D) On/Off Switch Yes	2 Wire Connection No Plugs LED	
	9986049	LED Interior Strip Lamp > Universal Applications FiveStar Products universal 24v LED interior strip lamp module. 2.2 Watt output with 24 LED's. Mounted in a low profile aluminium housing. 2 Wire connection : Red = Positive, Black = Negative. On/Off switch. 'On' mounted on the front of the lamp. - - Overall Dimensions : 1106mm (L) x 44mm (H) x 15mm (D) On/Off Switch Yes	2 Wire Connection No Plugs LED	
	9986050	LED Interior Strip Lamp > Universal Applications FiveStar Products universal 12v LED interior strip lamp module. 15 Watt output with 31 SMD LED's. Slimline design. Cool white LED's simulate a flourescent tube. 2 Wire connection : Red = Positive, Black = Negative. - - Overall Dimensions : 300mm (L) x 25mm (H) x 10mm (D) On/Off Switch No	2 Wire Connection No Plugs LED	
	9986051	LED Interior Strip Lamp > Universal Applications FiveStar Products universal 24v LED interior strip lamp module. 2.2 Watt output with 48 LED's. Designed to be intergrated into vehicle bodywork. 2 Wire connection : Red = Positive, Black = Negative. - - Overall Dimensions : 1000mm (L) x 18mm (H) x 11mm (D) On/Off Switch No	2 Wire Connection No Plugs LED	
5.1	Bowers	Sales Order Hotline : 01782 590700	B&C	5.1

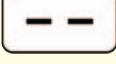

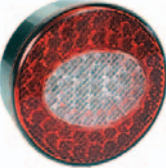
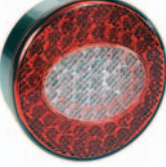
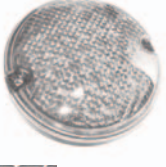
Lighting Products	Additional	Part Description	Part No.	Lighting Products
	<p>2 Wire Connection No Plugs</p> <hr/> <p>LED</p>	<p>LED Interior Strip Lamp > Universal Applications FiveStar Products universal 12v LED interior strip lamp module. 15 Watt output with 31 SMD LED's. Slimline design. Cool white LED's simulate a fluorescent tube. 2 Wire connection : Red = Positive, Black = Negative. - - Overall Dimensions : 150mm (L) x 25mm (H) x 10mm (D)</p> <p>On/Off Switch No</p>	9986061	
	<p>2 Wire Connection No Plugs</p> <hr/> <p>LED</p>	<p>LED Interior Strip Lamp > Universal Applications FiveStar Products universal 12v LED interior strip lamp module. 15 Watt output with 121 SMD LED's. Slimline design. Cool white LED's simulate a fluorescent tube. 2 Wire connection : Red = Positive, Black = Negative. - - Overall Dimensions : 600mm (L) x 25mm (H) x 10mm (D)</p> <p>On/Off Switch No</p>	9986063	
		<p>Rear Combination Lamp > Universal Applications FiveStar Products rear combination lamp. Stop / Tail / Directional indicator, with number plate light. Plastic body and lens. 2 Bolt fixing. Plug / Termination positioned on the back of the lamp. Suitable for both right and left hand applications. Suitable for 12V and 24V applications, (Bulbs not included). LED Versions available without number plate light, (See 9991098, 9991186). - Overall Dimensions : 140mm (Dia) x 78mm (D)</p> <p>Voltage N/a. Side N/a. With No. Plate Light Yes Spare Lens 9988019, 9988101</p>	9991001	
		<p>Rear Combination Lamp > Universal Applications FiveStar Products rear combination lamp. Stop / Tail / Directional indicator, without number plate light. Plastic body and lens. 2 Bolt fixing. Features a reflector. Plug / Termination positioned on the back of the lamp. Suitable for both right and left hand applications. Suitable for 12V and 24V applications, (Bulbs not included). LED Versions available, (See 9991098, 9991186). - Overall Dimensions : 140mm (Dia) x 78mm (D)</p> <p>Voltage N/a. Side N/a. With No. Plate Light No Spare Lens 9988019, 9988101</p>	9991002	
		<p>Rear Indicator Lamp > Universal Applications FiveStar Products rear directional indicator lamp. Plastic body and lens. 2 Bolt fixing. Plug / Termination positioned on the centre back of the lamp. Suitable for both right and left hand applications. Suitable for 12V and 24V applications, (Bulbs not included). - - Overall Dimensions : 116mm (L) x 140mm (H) x 60mm (D)</p> <p>Voltage N/a. Side N/a. Function Indicator Spare Lens 9988006</p>	9991009	
		<p>Rear Tail Lamp > Universal Applications FiveStar Products rear tail lamp. Plastic body and lens. 2 Bolt fixing. Plug / Termination positioned on the centre back of the lamp. Suitable for both right and left hand applications. Suitable for 12V and 24V applications, (Bulbs not included). - - Overall Dimensions : 116mm (L) x 140mm (H) x 60mm (D)</p> <p>Voltage N/a. Side N/a. Function Tail Spare Lens 9988007</p>	9991010	
		<p>Rear Stop Lamp > Universal Applications FiveStar Products rear stop lamp. Plastic body and lens. 2 Bolt fixing. Plug / Termination positioned on the centre back of the lamp. Suitable for both right and left hand applications. Suitable for 12V and 24V applications, (Bulbs not included). - - Overall Dimensions : 116mm (L) x 140mm (H) x 60mm (D)</p> <p>Voltage N/a. Side N/a. Function Stop Spare Lens 9988008</p>	9991011	
		<p>Rear Fog Lamp > Universal Applications FiveStar Products rear fog lamp. Plastic body and lens. 2 Bolt fixing. Plug / Termination positioned on the centre back of the lamp. Suitable for both right and left hand applications. Suitable for 12V and 24V applications, (Bulbs not included). - - Overall Dimensions : 116mm (L) x 140mm (H) x 60mm (D)</p> <p>Voltage N/a. Side N/a. Function Fog Spare Lens 9988009</p>	9991012	
5.2	B&C	Website : www.bowersmidland.co.uk	Bowers	5.2



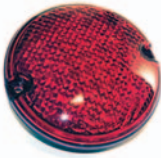
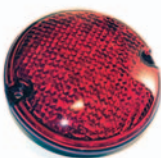
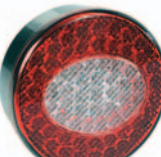
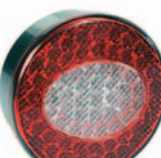
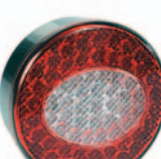
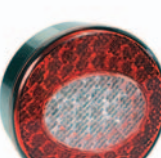



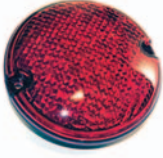
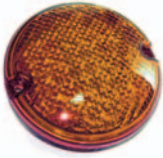







Lighting Products	Part No.	Part Description	Additional	Lighting Products
	9991013	Rear Reverse Lamp > Universal Applications FiveStar Products rear reverse lamp. Plastic body and lens. 2 Bolt fixing. Plug / Termination positioned on the centre back of the lamp. Suitable for both right and left hand applications. Suitable for 12V and 24V applications, (Bulbs not included). - - Overall Dimensions : 116mm (L) x 140mm (H) x 60mm (D) Voltage Side Function Spare Lens N/a. N/a. Reverse 9988010		
 <i>Rubbolite</i>	9991057	Rear Reverse Lamp > Universal Applications FiveStar Products rear reverse lamp. Plastic body and lens. 2 Bolt fixing. Plug / Termination positioned on the back of the lamp. Suitable for both right and left hand applications. Suitable for 12V and 24V applications, (Bulbs not included). - - Overall Dimensions : 140mm (Dia) x 80mm (D) Voltage Side Function Spare Lens N/a. N/a. Reverse 9988010		
 <i>Rubbolite</i>	9991058	Rear Fog Lamp > Universal Applications FiveStar Products rear fog lamp. Plastic body and lens. 2 Bolt fixing. Plug / Termination positioned on the back of the lamp. Suitable for both right and left hand applications. Suitable for 12V and 24V applications, (Bulbs not included). - - Overall Dimensions : 140mm (Dia) x 80mm (D) Voltage Side Function Spare Lens N/a. N/a. Fog 9988010		
 <i>PEREJ</i>	9991080	Rear Fog Lamp > Universal Applications FiveStar Products rear fog lamp. Plastic body and lens. 2 Screw fixing. Plug / Termination positioned on the centre back of the lamp. Suitable for both right and left hand applications. Suitable for 12V and 24V applications, (Bulbs not included). - - Overall Dimensions : 95mm (Dia) x 100mm (D) Voltage Side Function Spare Lens N/a. N/a. Fog N/a.		
 <i>PEREJ</i>	9991083	Rear Reverse Lamp > Universal Applications FiveStar Products rear reverse lamp. Plastic body and lens. 2 Screw fixing. Plug / Termination positioned on the centre back of the lamp. Suitable for both right and left hand applications. Suitable for 12V and 24V applications, (Bulbs not included). - - Overall Dimensions : 95mm (Dia) x 100mm (D) Voltage Side Function Spare Lens N/a. N/a. Reverse N/a.		
 <i>PEREJ</i>	9991089	Front Indicator Lamp > Universal Applications FiveStar Products front indicator lamp. Plastic body and lens. 2 Screw fixing. Plug / Termination positioned on the centre back of the lamp. Suitable for both right and left hand applications. Suitable for 12V and 24V applications, (Bulbs not included). - - Overall Dimensions : 95mm (Dia) x 100mm (D) Voltage Side Function Spare Lens N/a. N/a. Indicator N/a.		
 <i>PEREJ</i>	9991090	Rear Indicator Lamp > Universal Applications FiveStar Products rear indicator lamp. Plastic body and lens. 2 Screw fixing. Plug / Termination positioned on the centre back of the lamp. Suitable for both right and left hand applications. Suitable for 12V and 24V applications, (Bulbs not included). - - Overall Dimensions : 95mm (Dia) x 100mm (D) Voltage Side Function Spare Lens N/a. N/a. Indicator N/a.		
 <i>PEREJ</i>	9991091	Front Position Lamp > Universal Applications FiveStar Products front position lamp. Plastic body and lens. 2 Screw fixing. Plug / Termination positioned on the centre back of the lamp. Suitable for both right and left hand applications. Suitable for 12V and 24V applications, (Bulbs not included). - - Overall Dimensions : 95mm (Dia) x 100mm (D) Voltage Side Function Spare Lens N/a. N/a. Position N/a.		
5.3	Bowers	Sales Order Hotline : 01782 590700	B&C	5.3

Lighting Products	Additional	Part Description	Part No.	Lighting Products								
		Rear Marker Lamp > Universal Applications FiveStar Products rear red marker lamp. Plastic body and lens. 2 Screw fixing. Plug / Termination positioned on the centre back of the lamp. Suitable for both right and left hand applications. Suitable for 12V and 24V applications, (Bulbs not included). - - Overall Dimensions : 95mm (Dia) x 100mm (D) <table border="1"> <thead> <tr> <th>Voltage</th> <th>Side</th> <th>Function</th> <th>Spare Lens</th> </tr> </thead> <tbody> <tr> <td>N/a.</td> <td>N/a.</td> <td>Marker</td> <td>N/a.</td> </tr> </tbody> </table>	Voltage	Side	Function	Spare Lens	N/a.	N/a.	Marker	N/a.	9991092	 <i>PEREI</i>
Voltage	Side	Function	Spare Lens									
N/a.	N/a.	Marker	N/a.									
		Rear Stop/Tail Lamp > Universal Applications FiveStar Products rear stop/tail lamp. Plastic body and lens. 2 Screw fixing. Plug / Termination positioned on the centre back of the lamp. Suitable for both right and left hand applications. Suitable for 12V and 24V applications, (Bulbs not included). - - Overall Dimensions : 95mm (Dia) x 100mm (D) <table border="1"> <thead> <tr> <th>Voltage</th> <th>Side</th> <th>Function</th> <th>Spare Lens</th> </tr> </thead> <tbody> <tr> <td>N/a.</td> <td>N/a.</td> <td>Stop/Tail</td> <td>N/a.</td> </tr> </tbody> </table>	Voltage	Side	Function	Spare Lens	N/a.	N/a.	Stop/Tail	N/a.	9991093	 <i>PEREI</i>
Voltage	Side	Function	Spare Lens									
N/a.	N/a.	Stop/Tail	N/a.									
		Rear Stop Lamp > Universal Applications FiveStar Products rear stop lamp. Plastic body and lens. 2 Screw fixing. Plug / Termination positioned on the centre back of the lamp. Suitable for both right and left hand applications. Suitable for 12V and 24V applications, (Bulbs not included). - - Overall Dimensions : 95mm (Dia) x 100mm (D) <table border="1"> <thead> <tr> <th>Voltage</th> <th>Side</th> <th>Function</th> <th>Spare Lens</th> </tr> </thead> <tbody> <tr> <td>N/a.</td> <td>N/a.</td> <td>Stop</td> <td>N/a.</td> </tr> </tbody> </table>	Voltage	Side	Function	Spare Lens	N/a.	N/a.	Stop	N/a.	9991094	 <i>PEREI</i>
Voltage	Side	Function	Spare Lens									
N/a.	N/a.	Stop	N/a.									
	 LED	LED Rear Combination Lamp > Universal Applications FiveStar Products LED rear combination lamp. Stop / Tail / Directional indicator, without number plate light. Plastic body and lens. 2 Bolt fixing. Plug / Termination positioned on the back of the lamp. Suitable for both right and left hand applications. Optional load device 9997062 may be required to simulate the directional indicator bulb for the flasher unit to operate correctly. The optional load device is for use with 24v systems. Bulb type versions available, (See 9991001, 9991002). Overall Dimensions : 140mm (Dia) x 78mm (D) <table border="1"> <thead> <tr> <th>Voltage</th> <th>Side</th> <th>With No. Plate Light</th> <th>Spare Lens</th> </tr> </thead> <tbody> <tr> <td>24V</td> <td>N/a.</td> <td>No</td> <td>9988019, 9988101</td> </tr> </tbody> </table>	Voltage	Side	With No. Plate Light	Spare Lens	24V	N/a.	No	9988019, 9988101	9991098	 <i>PEREI</i>
Voltage	Side	With No. Plate Light	Spare Lens									
24V	N/a.	No	9988019, 9988101									
	 LED	LED Rear Combination Lamp > Universal Applications FiveStar Products LED rear combination lamp. Stop / Tail, without number plate light. Plastic body and lens. 2 Bolt fixing. Plug / Termination positioned on the back of the lamp. Suitable for both right and left hand applications. - - Overall Dimensions : 140mm (Dia) x 78mm (D) <table border="1"> <thead> <tr> <th>Voltage</th> <th>Side</th> <th>With No. Plate Light</th> <th>Spare Lens</th> </tr> </thead> <tbody> <tr> <td>24V</td> <td>N/a.</td> <td>No</td> <td>N/a.</td> </tr> </tbody> </table>	Voltage	Side	With No. Plate Light	Spare Lens	24V	N/a.	No	N/a.	9991099	 <i>PEREI</i>
Voltage	Side	With No. Plate Light	Spare Lens									
24V	N/a.	No	N/a.									
	 LED	LED Rear Fog Lamp > Universal Applications FiveStar Products LED rear fog lamp. Stop / Tail, without number plate light. Plastic body and lens. 2 Bolt fixing. Plug / Termination positioned on the back of the lamp. Suitable for both right and left hand applications. - - Overall Dimensions : 140mm (Dia) x 78mm (D) <table border="1"> <thead> <tr> <th>Voltage</th> <th>Side</th> <th>With No. Plate Light</th> <th>Spare Lens</th> </tr> </thead> <tbody> <tr> <td>24V</td> <td>N/a.</td> <td>No</td> <td>N/a.</td> </tr> </tbody> </table>	Voltage	Side	With No. Plate Light	Spare Lens	24V	N/a.	No	N/a.	9991137	 <i>PEREI</i>
Voltage	Side	With No. Plate Light	Spare Lens									
24V	N/a.	No	N/a.									
	 LED	LED Rear Reverse Lamp > Universal Applications FiveStar Products LED rear reverse lamp. Stop / Tail, without number plate light. Plastic body and lens. 2 Bolt fixing. Plug / Termination positioned on the back of the lamp. Suitable for both right and left hand applications. - - Overall Dimensions : 140mm (Dia) x 78mm (D) <table border="1"> <thead> <tr> <th>Voltage</th> <th>Side</th> <th>With No. Plate Light</th> <th>Spare Lens</th> </tr> </thead> <tbody> <tr> <td>24V</td> <td>N/a.</td> <td>No</td> <td>N/a.</td> </tr> </tbody> </table>	Voltage	Side	With No. Plate Light	Spare Lens	24V	N/a.	No	N/a.	9991138	 <i>PEREI</i>
Voltage	Side	With No. Plate Light	Spare Lens									
24V	N/a.	No	N/a.									
	 LED	LED Rear Combination Lamp > Universal Applications FiveStar Products LED rear combination lamp. Stop / Tail / Directional indicator, without number plate light. Plastic body and lens. 2 Bolt fixing. Plug / Termination positioned on the back of the lamp. Suitable for both right and left hand applications. Optional load device 9997062 may be required to simulate the directional indicator bulb for the flasher unit to operate correctly. The optional load device is for use with 24v systems. Bulb type versions available, (See 9991001, 9991002). Overall Dimensions : 140mm (Dia) x 78mm (D) <table border="1"> <thead> <tr> <th>Voltage</th> <th>Side</th> <th>With No. Plate Light</th> <th>Spare Lens</th> </tr> </thead> <tbody> <tr> <td>3-33V</td> <td>N/a.</td> <td>No</td> <td>9988019, 9988101</td> </tr> </tbody> </table>	Voltage	Side	With No. Plate Light	Spare Lens	3-33V	N/a.	No	9988019, 9988101	9991186	 <i>PEREI</i>
Voltage	Side	With No. Plate Light	Spare Lens									
3-33V	N/a.	No	9988019, 9988101									
5.4	B&C	Website : www.bowersmidland.co.uk	Bowers	5.4								



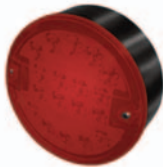





Lighting Products	Part No.	Part Description	Additional	Lighting Products
 PEREI	9991187	Rear Indicator Lamp > Universal Applications FiveStar Products rear indicator lamp. Plastic body and lens. Plug / Termination positioned on the centre back of the lamp. Suitable for both right and left hand applications. Suitable for 12V and 24V applications, (Bulbs not included). Features a 2 pin superseal connection. - Overall Dimensions : 95mm (Dia) x 75mm (D) Voltage Side Function Spare Lens N/a. N/a. Indicator N/a.		
 PEREI	9991188	Rear Reverse Lamp > Universal Applications FiveStar Products rear reverse lamp. Plastic body and lens. Plug / Termination positioned on the centre back of the lamp. Suitable for both right and left hand applications. Suitable for 12V and 24V applications, (Bulbs not included). Features a 2 pin superseal connection. - Overall Dimensions : 95mm (Dia) x 75mm (D) Voltage Side Function Spare Lens N/a. N/a. Reverse N/a.		
 PEREI	9991189	Rear Fog Lamp > Universal Applications FiveStar Products rear fog lamp. Plastic body and lens. Plug / Termination positioned on the centre back of the lamp. Suitable for both right and left hand applications. Suitable for 12V and 24V applications, (Bulbs not included). Features a 2 pin superseal connection. - Overall Dimensions : 95mm (Dia) x 75mm (D) Voltage Side Function Spare Lens N/a. N/a. Fog N/a.		
 PEREI	9991190	Rear Stop / Tail Lamp > Universal Applications FiveStar Products rear stop / tail lamp. Plastic body and lens. Plug / Termination positioned on the centre back of the lamp. Suitable for both right and left hand applications. Suitable for 12V and 24V applications, (Bulbs not included). Features a 2 pin superseal connection. - Overall Dimensions : 95mm (Dia) x 75mm (D) Voltage Side Function Spare Lens N/a. N/a. Stop / Tail N/a.		
 PEREI	9991194	LED Rear Combination Lamp > Universal Applications FiveStar Products LED rear combination lamp. Stop / Tail / Directional indicator, without number plate light. Plastic body and lens. 2 Bolt fixing. Plug / Termination positioned on the back of the lamp. Suitable for both right and left hand applications. Low current draw. Developed for use in high temperatures. ECE approval for all functions. 24V versions available, (See 9991195). - Overall Dimensions : 120mm (Dia) x 48mm (D) Voltage Side With No. Plate Light Spare Lens 12V N/a. No N/a.	4 Core Cable No Plugs LED	
 PEREI	9991195	LED Rear Combination Lamp > Universal Applications FiveStar Products LED rear combination lamp. Stop / Tail / Directional indicator, without number plate light. Plastic body and lens. 2 Bolt fixing. Plug / Termination positioned on the back of the lamp. Suitable for both right and left hand applications. Low current draw. Developed for use in high temperatures. ECE approval for all functions. 12V versions available, (See 9991195). - Overall Dimensions : 120mm (Dia) x 48mm (D) Voltage Side With No. Plate Light Spare Lens 24V N/a. No N/a.	4 Core Cable No Plugs LED	
 PEREI	9991196	LED Rear Reverse Lamp > Universal Applications FiveStar Products LED rear reverse lamp. Plastic body and lens. 2 Bolt fixing. Plug / Termination positioned on the back of the lamp. Suitable for both right and left hand applications. 24V versions available, (See 9991220). - Overall Dimensions : 95mm (Dia) x 35mm (D) Voltage Side Function Spare Lens 12V N/a. Reverse N/a.	2 Wire Connection No Plugs LED	
 PEREI	9991197	LED Rear Indicator Lamp > Universal Applications FiveStar Products LED rear indicator lamp. Plastic body and lens. 2 Bolt fixing. Plug / Termination positioned on the back of the lamp. Suitable for both right and left hand applications. 24V versions available, (See 9991222). - Overall Dimensions : 95mm (Dia) x 35mm (D) Voltage Side Function Spare Lens 12V N/a. Indicator N/a.	2 Wire Connection No Plugs LED	
5.5	Bowers	Sales Order Hotline : 01782 590700	B&C	5.5









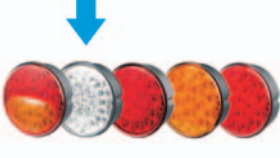

Lighting Products	Additional	Part Description	Part No.	Lighting Products
	2 Wire Connection No Plugs	LED Rear Fog Lamp > Universal Applications FiveStar Products LED rear fog lamp. Plastic body and lens. 2 Bolt fixing. Plug / Termination positioned on the back of the lamp. Suitable for both right and left hand applications. 24V versions available, (See 9991221). - Overall Dimensions : 95mm (Dia) x 35mm (D)	9991198	 PEREI
	LED	Voltage 12V Side N/a. Function Fog Spare Lens N/a.		
	2 Wire Connection No Plugs	LED Rear Stop / Tail Lamp > Universal Applications FiveStar Products LED rear stop / tail lamp. Plastic body and lens. 2 Bolt fixing. Plug / Termination positioned on the back of the lamp. Suitable for both right and left hand applications. 24V versions available, (See 9991219). - Overall Dimensions : 95mm (Dia) x 35mm (D)	9991199	 PEREI
	LED	Voltage 12V Side N/a. Function Stop / Tail Spare Lens N/a.		
	4 Core Cable No Plugs	LED Rear Reverse / Fog Lamp > Universal Applications FiveStar Products LED rear reverse / fog lamp. Plastic body and lens. 2 Bolt fixing. Plug / Termination positioned on the back of the lamp. Suitable for both right and left hand applications. Low current draw. Developed for use in high temperatures. ECE approval for all functions. 24V versions available, (See 9991203). - Overall Dimensions : 120mm (Dia) x 48mm (D)	9991200	 PEREI
	LED	Voltage 12V Side N/a. Function Reverse / Fog Spare Lens N/a.		
	4 Core Cable No Plugs	LED Rear Reverse Lamp > Universal Applications FiveStar Products LED rear reverse lamp. Plastic body and lens. 2 Bolt fixing. Plug / Termination positioned on the back of the lamp. Suitable for both right and left hand applications. Low current draw. Developed for use in high temperatures. ECE approval for all functions. 24V versions available, (See 9991204). - Overall Dimensions : 120mm (Dia) x 48mm (D)	9991201	 PEREI
	LED	Voltage 12V Side N/a. Function Reverse Spare Lens N/a.		
	4 Core Cable No Plugs	LED Rear Fog Lamp > Universal Applications FiveStar Products LED rear fog lamp. Plastic body and lens. 2 Bolt fixing. Plug / Termination positioned on the back of the lamp. Suitable for both right and left hand applications. Low current draw. Developed for use in high temperatures. ECE approval for all functions. 24V versions available, (See 9991205). - Overall Dimensions : 120mm (Dia) x 48mm (D)	9991202	 PEREI
	LED	Voltage 12V Side N/a. Function Fog Spare Lens N/a.		
	4 Core Cable No Plugs	LED Rear Reverse / Fog Lamp > Universal Applications FiveStar Products LED rear reverse / fog lamp. Plastic body and lens. 2 Bolt fixing. Plug / Termination positioned on the back of the lamp. Suitable for both right and left hand applications. Low current draw. Developed for use in high temperatures. ECE approval for all functions. 12V versions available, (See 9991200). - Overall Dimensions : 120mm (Dia) x 48mm (D)	9991203	 PEREI
	LED	Voltage 24V Side N/a. Function Reverse / Fog Spare Lens N/a.		
	4 Core Cable No Plugs	LED Rear Reverse Lamp > Universal Applications FiveStar Products LED rear reverse lamp. Plastic body and lens. 2 Bolt fixing. Plug / Termination positioned on the back of the lamp. Suitable for both right and left hand applications. Low current draw. Developed for use in high temperatures. ECE approval for all functions. 12V versions available, (See 9991201). - Overall Dimensions : 120mm (Dia) x 48mm (D)	9991204	 PEREI
	LED	Voltage 24V Side N/a. Function Reverse Spare Lens N/a.		
	4 Core Cable No Plugs	LED Rear Fog Lamp > Universal Applications FiveStar Products LED rear fog lamp. Plastic body and lens. 2 Bolt fixing. Plug / Termination positioned on the back of the lamp. Suitable for both right and left hand applications. Low current draw. Developed for use in high temperatures. ECE approval for all functions. 12V versions available, (See 9991202). - Overall Dimensions : 120mm (Dia) x 48mm (D)	9991205	 PEREI
	LED	Voltage 24V Side N/a. Function Fog Spare Lens N/a.		
5.6	B&C	Website : www.bowersmidland.co.uk	Bowers	5.6

Lighting Products	Part No.	Part Description	Additional	Lighting Products								
 	9991218	LED Front Indicator Lamp > Universal Applications FiveStar Products LED front indicator lamp. Plastic body and lens. 2 Bolt fixing. Plug / Termination positioned on the back of the lamp. Suitable for both right and left hand applications. 24V versions available, (See 9991222). - - Overall Dimensions : 95mm (Dia) x 35mm (D) <table border="1" data-bbox="587 349 991 387"> <thead> <tr> <th>Voltage</th> <th>Side</th> <th>Function</th> <th>Spare Lens</th> </tr> </thead> <tbody> <tr> <td>12V</td> <td>N/a.</td> <td>Indicator</td> <td>N/a.</td> </tr> </tbody> </table>	Voltage	Side	Function	Spare Lens	12V	N/a.	Indicator	N/a.	2 Wire Connection No Plugs	
Voltage	Side	Function	Spare Lens									
12V	N/a.	Indicator	N/a.									
			LED									
 	9991219	LED Rear Stop / Tail Lamp > Universal Applications FiveStar Products LED rear stop / tail lamp. Plastic body and lens. 2 Bolt fixing. Plug / Termination positioned on the back of the lamp. Suitable for both right and left hand applications. 12V versions available, (See 9991199). - - Overall Dimensions : 95mm (Dia) x 35mm (D) <table border="1" data-bbox="587 589 991 627"> <thead> <tr> <th>Voltage</th> <th>Side</th> <th>Function</th> <th>Spare Lens</th> </tr> </thead> <tbody> <tr> <td>24V</td> <td>N/a.</td> <td>Stop / Tail</td> <td>N/a.</td> </tr> </tbody> </table>	Voltage	Side	Function	Spare Lens	24V	N/a.	Stop / Tail	N/a.	2 Wire Connection No Plugs	
Voltage	Side	Function	Spare Lens									
24V	N/a.	Stop / Tail	N/a.									
			LED									
 	9991220	LED Rear Reverse Lamp > Universal Applications FiveStar Products LED rear reverse lamp. Plastic body and lens. 2 Bolt fixing. Plug / Termination positioned on the back of the lamp. Suitable for both right and left hand applications. 12V versions available, (See 9991196). - - Overall Dimensions : 95mm (Dia) x 35mm (D) <table border="1" data-bbox="587 833 991 871"> <thead> <tr> <th>Voltage</th> <th>Side</th> <th>Function</th> <th>Spare Lens</th> </tr> </thead> <tbody> <tr> <td>24V</td> <td>N/a.</td> <td>Reverse</td> <td>N/a.</td> </tr> </tbody> </table>	Voltage	Side	Function	Spare Lens	24V	N/a.	Reverse	N/a.	2 Wire Connection No Plugs	
Voltage	Side	Function	Spare Lens									
24V	N/a.	Reverse	N/a.									
			LED									
 	9991221	LED Rear Fog Lamp > Universal Applications FiveStar Products LED rear fog lamp. Plastic body and lens. 2 Bolt fixing. Plug / Termination positioned on the back of the lamp. Suitable for both right and left hand applications. 12V versions available, (See 9991198). - - Overall Dimensions : 95mm (Dia) x 35mm (D) <table border="1" data-bbox="587 1072 991 1111"> <thead> <tr> <th>Voltage</th> <th>Side</th> <th>Function</th> <th>Spare Lens</th> </tr> </thead> <tbody> <tr> <td>24V</td> <td>N/a.</td> <td>Fog</td> <td>N/a.</td> </tr> </tbody> </table>	Voltage	Side	Function	Spare Lens	24V	N/a.	Fog	N/a.	2 Wire Connection No Plugs	
Voltage	Side	Function	Spare Lens									
24V	N/a.	Fog	N/a.									
			LED									
 	9991222	LED Rear Indicator Lamp > Universal Applications FiveStar Products LED rear indicator lamp. Plastic body and lens. 2 Bolt fixing. Plug / Termination positioned on the back of the lamp. Suitable for both right and left hand applications. 12V versions available, (See 9991197). - - Overall Dimensions : 95mm (Dia) x 35mm (D) <table border="1" data-bbox="587 1312 991 1350"> <thead> <tr> <th>Voltage</th> <th>Side</th> <th>Function</th> <th>Spare Lens</th> </tr> </thead> <tbody> <tr> <td>24V</td> <td>N/a.</td> <td>Indicator</td> <td>N/a.</td> </tr> </tbody> </table>	Voltage	Side	Function	Spare Lens	24V	N/a.	Indicator	N/a.	2 Wire Connection No Plugs	
Voltage	Side	Function	Spare Lens									
24V	N/a.	Indicator	N/a.									
			LED									
 	9991223	LED Front Indicator Lamp > Universal Applications FiveStar Products LED front indicator lamp. Plastic body and lens. 2 Bolt fixing. Plug / Termination positioned on the back of the lamp. Suitable for both right and left hand applications. 12V versions available, (See 9991218). - - Overall Dimensions : 95mm (Dia) x 35mm (D) <table border="1" data-bbox="587 1552 991 1590"> <thead> <tr> <th>Voltage</th> <th>Side</th> <th>Function</th> <th>Spare Lens</th> </tr> </thead> <tbody> <tr> <td>24V</td> <td>N/a.</td> <td>Indicator</td> <td>N/a.</td> </tr> </tbody> </table>	Voltage	Side	Function	Spare Lens	24V	N/a.	Indicator	N/a.	2 Wire Connection No Plugs	
Voltage	Side	Function	Spare Lens									
24V	N/a.	Indicator	N/a.									
			LED									
	9991261	Front Indicator Lamp > Universal Applications FiveStar Products front indicator lamp. Metal body and lens. Supplie with rubber mount and covering cap. (Used for wire connections). Plug / Termination positioned on the back of the lamp. Suitable for both right and left hand applications. Suitable for 12V and 24V applications, (Bulbs not included). - - Overall Dimensions : 260mm (L) x 130mm (H) x 80mm (D) <table border="1" data-bbox="587 1792 991 1830"> <thead> <tr> <th>Voltage</th> <th>Side</th> <th>Function</th> <th>Spare Lens</th> </tr> </thead> <tbody> <tr> <td>N/a.</td> <td>N/a.</td> <td>Indicator</td> <td>N/a.</td> </tr> </tbody> </table>	Voltage	Side	Function	Spare Lens	N/a.	N/a.	Indicator	N/a.		
Voltage	Side	Function	Spare Lens									
N/a.	N/a.	Indicator	N/a.									
	9991262	Rear Indicator Lamp > Universal Applications FiveStar Products rear indicator lamp. Metal body and lens. Supplie with rubber mount and covering cap. (Used for wire connections). Plug / Termination positioned on the back of the lamp. Suitable for both right and left hand applications. Suitable for 12V and 24V applications, (Bulbs not included). - - Overall Dimensions : 260mm (L) x 130mm (H) x 80mm (D) <table border="1" data-bbox="587 2031 991 2069"> <thead> <tr> <th>Voltage</th> <th>Side</th> <th>Function</th> <th>Spare Lens</th> </tr> </thead> <tbody> <tr> <td>N/a.</td> <td>N/a.</td> <td>Indicator</td> <td>N/a.</td> </tr> </tbody> </table>	Voltage	Side	Function	Spare Lens	N/a.	N/a.	Indicator	N/a.		
Voltage	Side	Function	Spare Lens									
N/a.	N/a.	Indicator	N/a.									
5.7	Bowers	Sales Order Hotline : 01782 590700	B&C	5.7								

Lighting Products	Additional	Part Description	Part No.	Lighting Products
		Rear Stop Lamp > Universal Applications FiveStar Products rear stop lamp. Metal body and lens. Supplie with rubber mount and covering cap, (Used for wire connections). Plug / Termination positioned on the back of the lamp. Suitable for both right and left hand applications. Suitable for 12V and 24V applications, (Bulbs not included). - - Overall Dimensions : 260mm (L) x 130mm (H) x 80mm (D) Voltage Side Function Spare Lens N/a. N/a. Stop N/a.	9991263	
		Rear Tail Lamp > Universal Applications FiveStar Products rear tail lamp. Metal body and lens. Supplie with rubber mount and covering cap, (Used for wire connections). Plug / Termination positioned on the back of the lamp. Suitable for both right and left hand applications. Suitable for 12V and 24V applications, (Bulbs not included). - - Overall Dimensions : 260mm (L) x 130mm (H) x 80mm (D) Voltage Side Function Spare Lens N/a. N/a. Tail N/a.	9991264	
		Rear Stop / Tail Lamp > Universal Applications FiveStar Products rear stop / tail lamp. Metal body and lens. Supplie with rubber mount and covering cap, (Used for wire connections). Plug / Termination positioned on the back of the lamp. Suitable for both right and left hand applications. Suitable for 12V and 24V applications, (Bulbs not included). - - Overall Dimensions : 260mm (L) x 130mm (H) x 80mm (D) Voltage Side Function Spare Lens N/a. N/a. Stop / Tail N/a.	9991265	
		Rear Fog Lamp > Universal Applications FiveStar Products rear fog lamp. Metal body and lens. Supplie with rubber mount and covering cap, (Used for wire connections). Plug / Termination positioned on the back of the lamp. Suitable for both right and left hand applications. Suitable for 12V and 24V applications, (Bulbs not included). - - Overall Dimensions : 260mm (L) x 130mm (H) x 80mm (D) Voltage Side Function Spare Lens N/a. N/a. Fog N/a.	9991266	
		Rear Reverse Lamp > Universal Applications FiveStar Products rear reverse lamp. Metal body and lens. Supplie with rubber mount and covering cap, (Used for wire connections). Plug / Termination positioned on the back of the lamp. Suitable for both right and left hand applications. Suitable for 12V and 24V applications, (Bulbs not included). - - Overall Dimensions : 260mm (L) x 130mm (H) x 80mm (D) Voltage Side Function Spare Lens N/a. N/a. Reverse N/a.	9991267	
	 LED	LED Rear Fog Lamp > Universal Applications FiveStar Products LED rear fog lamp. Plastic body and lens. 2 Bolt fixing. Features 14 LED's. Plug / Termination positioned on the back of the lamp. Suitable for both right and left hand applications. - - Overall Dimensions : 140mm (Dia) x 70mm (D) Voltage Side Function Spare Lens 12-24V N/a. Fog N/a.	9991328	
	 LED	LED Rear Reverse Lamp > Universal Applications FiveStar Products LED rear reverse lamp. Plastic body and lens. 2 Bolt fixing. Features 14 LED's. Plug / Termination positioned on the back of the lamp. Suitable for both right and left hand applications. - - Overall Dimensions : 140mm (Dia) x 70mm (D) Voltage Side Function Spare Lens 12-24V N/a. Reverse N/a.	9991329	
	Wire Connection No Plugs LED	LED Stop / Tail Lamp > Universal Applications Rear 24V Stop / Tail lamp. Plastic body & lens. ECE Approved. - - - Overall Dimensions : 84mm (Dia) x 40mm (D) Voltage Side Function Spare Lens 24V N/a. Stop / Tail N/a.	9991410	 PERE!
5.8	B&C	Website : www.bowersmidland.co.uk	Bowers	5.8

Lighting Products	Part No.	Part Description	Additional	Lighting Products
 PEREI	9991411	LED Front Indicator Lamp > Universal Applications Rear 24V Front Indicator lamp. Plastic body & lens. ECE Approved. - - - - Overall Dimensions : 84mm (Dia) x 40mm (D) Voltage Side Function Spare Lens 24V N/a. Indicator N/a.	Wire Connection No Plugs LED	
 PEREI	9991412	LED Rear Indicator Lamp > Universal Applications Rear 24V Rear Indicator lamp. Plastic body & lens. ECE Approved. - - - - Overall Dimensions : 84mm (Dia) x 40mm (D) Voltage Side Function Spare Lens 24V N/a. Indicator N/a.	Wire Connection No Plugs LED	
 PEREI	9991413	LED Rear Fog Lamp > Universal Applications Rear 24V Rear Fog lamp. Plastic body & lens. ECE Approved. - - - - Overall Dimensions : 84mm (Dia) x 40mm (D) Voltage Side Function Spare Lens 24V N/a. Fog N/a.	Wire Connection No Plugs LED	
 PEREI	9991414	LED Reverse Lamp > Universal Applications Rear 24V Reverse lamp. Plastic body & lens. ECE Approved. - - - - Overall Dimensions : 84mm (Dia) x 40mm (D) Voltage Side Function Spare Lens 24V N/a. Reverse N/a.	Wire Connection No Plugs LED	
	9991420	LED Stop / Tail Lamp > Universal Applications Dual voltage Stop / Tail lamp featuring 17 LEDs. ABS Housing & PMMA lens. ECE Approved. Fully sealed IP67 rated unit. Low power consumption. Long life LED light source. Reverse polarity protection. Complete with fly lead. 2x Mounting holes on 80mm fixing centres. Mounting plate available with 2x 6mm threaded inserts on 45mm fixing centres. 2W Stop, 0.5W Tail. - Overall Dimensions : 95mm (Dia) x 36mm (D) Voltage Side Function Spare Lens Mounting Plate 12-24V N/a. Stop / Tail N/a. 9991426	3 Wire Connection No Plugs LED	
	9991421	LED Indicator Lamp > Universal Applications Dual voltage Indicator lamp featuring 17 LEDs. ABS Housing & PMMA lens. ECE Approved. Fully sealed IP67 rated unit. Low power consumption. Long life LED light source. Reverse polarity protection. Complete with fly lead. 2x Mounting holes on 80mm fixing centres. Mounting plate available with 2x 6mm threaded inserts on 45mm fixing centres. 2W Indicator. - Overall Dimensions : 95mm (Dia) x 36mm (D) Voltage Side Function Spare Lens Mounting Plate 12-24V N/a. Indicator N/a. 9991426	2 Wire Connection No Plugs LED	
	9991422	LED Stop / Tail / Indicator Lamp > Universal Applications Dual voltage Stop / Tail / Indicator lamp featuring 17 LEDs. ABS Housing & PMMA lens. ECE Approved. Fully sealed IP67 rated unit. Low power consumption. Long life LED light source. Reverse polarity protection. Complete with fly lead. 2x Mounting holes on 80mm fixing centres. Mounting plate available with 2x 6mm threaded inserts on 45mm fixing centres. 2W Stop, 0.5W Tail, 1.5W Indicator. - Overall Dimensions : 95mm (Dia) x 36mm (D) Voltage Side Function Spare Lens Mounting Plate 12-24V N/a. Stop/Tail/Ind N/a. 9991426	4 Wire Connection No Plugs LED	
	9991423	LED Rear Fog Lamp > Universal Applications Dual voltage Rear Fog lamp featuring 17 LEDs. ABS Housing & PMMA lens. ECE Approved. Fully sealed IP67 rated unit. Low power consumption. Long life LED light source. Reverse polarity protection. Complete with fly lead. 2x Mounting holes on 80mm fixing centres. Mounting plate available with 2x 6mm threaded inserts on 45mm fixing centres. 2W Fog. - Overall Dimensions : 95mm (Dia) x 36mm (D) Voltage Side Function Spare Lens Mounting Plate 12-24V N/a. Fog N/a. 9991426	2 Wire Connection No Plugs LED	
5.9	Bowers	Sales Order Hotline : 01782 590700	B&C	5.9

Lighting Products	Additional	Part Description	Part No.	Lighting Products
	3 Wire Connection No Plugs	LED Front Position Indicator Lamp > Universal Applications Dual voltage Front Position Indicator lamp featuring 17 LEDs. ABS Housing & PMMA lens. ECE Approved. Fully sealed IP67 rated unit. Low power consumption. Long life LED light source. Reverse polarity protection. Complete with fly lead. 2x Mounting holes on 80mm fixing centres. Mounting plate available with 2x 6mm threaded inserts on 45mm fixing centres. 1.5W Reverse. - Overall Dimensions : 95mm (Dia) x 36mm (D)	9991424	
	LED	Voltage 12-24V Side N/a. Function Position Spare Lens N/a. Mounting Plate 9991426		
	2 Wire Connection No Plugs	LED Reverse Lamp > Universal Applications Dual voltage Reverse lamp featuring 17 LEDs. ABS Housing & PMMA lens. ECE Approved. Fully sealed IP67 rated unit. Low power consumption. Long life LED light source. Reverse polarity protection. Complete with fly lead. 2x Mounting holes on 80mm fixing centres. Mounting plate available with 2x 6mm threaded inserts on 45mm fixing centres. 0.5W Fog, 1.5W Reverse. - Overall Dimensions : 95mm (Dia) x 36mm (D)	9991425	
	LED	Voltage 12-24V Side N/a. Function Reverse Spare Lens N/a. Mounting Plate 9991426		
	3 Wire Connection No Plugs	LED Stop / Tail Lamp > Universal Applications 24V Stop / Tail lamp featuring 18 LEDs. ABS Housing & PMMA lens. ECE Approved. Fully sealed IP67 rated unit. Low power consumption. Long life LED light source. Reverse polarity protection. Complete with fly lead. 2 Bolt M6 45mm centres fixings. 2x 6mm threaded inserts on 45mm fixing centres. 2W Stop, 0.5W Tail. - Overall Dimensions : 122mm (Dia) Slimline	9991429	
	LED	Voltage 24V Side N/a. Function Stop / Tail Spare Lens N/a.		
	2 Wire Connection No Plugs	LED Indicator Lamp > Universal Applications 24V Indicator lamp featuring 18 LEDs. ABS Housing & PMMA lens. ECE Approved. Fully sealed IP67 rated unit. Low power consumption. Long life LED light source. Reverse polarity protection. Complete with fly lead. 2 Bolt M6 45mm centres fixings. 2x 6mm threaded inserts on 45mm fixing centres. 2W Indicator. - Overall Dimensions : 122mm (Dia) Slimline	9991430	
	LED	Voltage 24V Side N/a. Function Indicator Spare Lens N/a.		
	3 Wire Connection No Plugs	LED Stop / Tail / Indicator Lamp > Universal Applications 24V Stop / Tail / Indicator lamp featuring 18 LEDs. ABS Housing & PMMA lens. ECE Approved. Fully sealed IP67 rated unit. Low power consumption. Long life LED light source. Reverse polarity protection. Complete with fly lead. 2 Bolt M6 45mm centres fixings. 2x 6mm threaded inserts on 45mm fixing centres. 2W Stop, 0.5W Tail, 1.5W Indicator. - Overall Dimensions : 122mm (Dia) Slimline	9991431	
	LED	Voltage 24V Side N/a. Function Stop/Tail/Ind Spare Lens N/a.		
	2 Wire Connection No Plugs	LED Rear Fog Lamp > Universal Applications 24V Rear Fog lamp featuring 18 LEDs. ABS Housing & PMMA lens. ECE Approved. Fully sealed IP67 rated unit. Low power consumption. Long life LED light source. Reverse polarity protection. Complete with fly lead. 2 Bolt M6 45mm centres fixings. 2x 6mm threaded inserts on 45mm fixing centres. 2W Fog. - Overall Dimensions : 122mm (Dia) Slimline	9991432	
	LED	Voltage 24V Side N/a. Function Fog Spare Lens N/a.		
	2 Wire Connection No Plugs	LED Reverse Lamp > Universal Applications 24V Reverse lamp featuring 18 LEDs. ABS Housing & PMMA lens. ECE Approved. Fully sealed IP67 rated unit. Low power consumption. Long life LED light source. Reverse polarity protection. Complete with fly lead. 2 Bolt 45mm centres fixings. 2x 6mm threaded inserts on 45mm fixing centres. 1.5W Reverse. - Overall Dimensions : 122mm (Dia) Slimline	9991433	
	LED	Voltage 24V Side N/a. Function Reverse Spare Lens N/a.		
	3 Wire Connection No Plugs	LED Reverse Lamp > Universal Applications 24V Fog / Reverse lamp featuring 18 LEDs. ABS Housing & PMMA lens. ECE Approved. Fully sealed IP67 rated unit. Low power consumption. Long life LED light source. Reverse polarity protection. Complete with fly lead. 2 Bolt 45mm centres fixings. 2x 6mm threaded inserts on 45mm fixing centres. 0.5W Fog, 1.5W Reverse. - Overall Dimensions : 122mm (Dia) Slimline	9991434	
	LED	Voltage 24V Side N/a. Function Fog / Rev Spare Lens N/a.		
5.10	B&C	Website : www.bowersmidland.co.uk	Bowers	5.10

Lighting Products	Part No.	Part Description	Additional	Lighting Products
 <i>Rubbolite</i>	RUB838/12/00	LED Rear Indicator Lamp > Universal Applications Compact, robust & fully sealed to reduce water damage. Supplied pre-wired. Full LED with a system voltage of 12v & 24v. Two mounting options: Screw mounted to mounting housing or recess mounted to flange. Polarity protected making it easier to wire to your vehicle and reducing the risk of damaging the LEDs. The slim profile reduces the risk of damage to the lamps on and off the road. EMC & ECE Approved. - Overall Dimensions : 122mm (Dia) x 48mm (D) Voltage 12-24V Side N/a. Function Indicator Spare Lens N/a.	2 Wire Connection No Plugs LED	
 <i>Rubbolite</i>	RUB838/13/00	LED Rear Fog Lamp > Universal Applications Compact, robust & fully sealed to reduce water damage. Supplied pre-wired. Full LED with a system voltage of 12v & 24v. Two mounting options: Screw mounted to mounting housing or recess mounted to flange. Polarity protected making it easier to wire to your vehicle and reducing the risk of damaging the LEDs. The slim profile reduces the risk of damage to the lamps on and off the road. EMC & ECE Approved. - Overall Dimensions : 122mm (Dia) x 48mm (D) Voltage 12-24V Side N/a. Function Fog Spare Lens N/a.	2 Wire Connection No Plugs LED	
 <i>Rubbolite</i>	RUB838/14/00	LED Reverse Lamp > Universal Applications Compact, robust & fully sealed to reduce water damage. Supplied pre-wired. Full LED with a system voltage of 12v & 24v. Two mounting options: Screw mounted to mounting housing or recess mounted to flange. Polarity protected making it easier to wire to your vehicle and reducing the risk of damaging the LEDs. The slim profile reduces the risk of damage to the lamps on and off the road. EMC & ECE Approved. - Overall Dimensions : 122mm (Dia) x 48mm (D) Voltage 12-24V Side N/a. Function Reverse Spare Lens N/a.	2 Wire Connection No Plugs LED	
 <i>Rubbolite</i>	RUB838/15/00	LED Stop / Tail / Indicator Lamp > Universal Applications Compact, robust & fully sealed to reduce water damage. Supplied pre-wired. Full LED with a system voltage of 12v & 24v. Two mounting options: Screw mounted to mounting housing or recess mounted to flange. Polarity protected making it easier to wire to your vehicle and reducing the risk of damaging the LEDs. The slim profile reduces the risk of damage to the lamps on and off the road. EMC & ECE Approved. - Overall Dimensions : 122mm (Dia) x 48mm (D) Voltage 12-24V Side N/a. Function Stop/Tail/Ind Spare Lens N/a.	4 Wire Connection No Plugs LED	
 <i>Rubbolite</i>	RUB838/17/00	LED Reverse / Fog Lamp > Universal Applications Compact, robust & fully sealed to reduce water damage. Supplied pre-wired. Full LED with a system voltage of 12v & 24v. Two mounting options: Screw mounted to mounting housing or recess mounted to flange. Polarity protected making it easier to wire to your vehicle and reducing the risk of damaging the LEDs. The slim profile reduces the risk of damage to the lamps on and off the road. EMC & ECE Approved. - Overall Dimensions : 122mm (Dia) x 48mm (D) Voltage 12-24V Side N/a. Function Rev / Fog Spare Lens N/a.	3 Wire Connection No Plugs LED	
 <i>Rubbolite</i>	RUB838/18/00	LED Stop / Tail Lamp + Reflector > Universal Applications Compact, robust & fully sealed to reduce water damage. Supplied pre-wired. Full LED with a system voltage of 12v & 24v. Two mounting options: Screw mounted to mounting housing or recess mounted to flange. Polarity protected making it easier to wire to your vehicle and reducing the risk of damaging the LEDs. The slim profile reduces the risk of damage to the lamps on and off the road. EMC & ECE Approved. - Overall Dimensions : 122mm (Dia) x 48mm (D) Voltage 12-24V Side N/a. Function Stop/Tail/Ref Spare Lens N/a.	3 Wire Connection No Plugs LED	
 	BMA343VRFS	RH Rear Combination Lamp > Universal Applications RH rear combination lamp. Stop / Tail / Directional Indicator / Fog / Reverse. Vertical fitting with silver bezel. Suitable for right hand applications. - - - Overall Dimensions : 397mm (L) x 165mm (H) x 65mm (D) Voltage N/a. Side RH Function 5 Spare Lens Centre 343/22 & Red : 343/30		
 	BMA343VLFS	LH Rear Combination Lamp > Universal Applications LH rear combination lamp. Stop / Tail / Directional Indicator / Fog / Reverse. Vertical fitting with silver bezel. Suitable for left hand applications. - - - Overall Dimensions : 397mm (L) x 165mm (H) x 65mm (D) Voltage N/a. Side LH Function 5 Spare Lens Centre 343/22 & Red : 343/30		
5.11	Bowers	Sales Order Hotline : 01782 590700	B&C	5.11

Lighting Products	Additional	Part Description	Part No.	Lighting Products								
	Fly Leads	<p>RH Rear Combination Lamp > Universal Applications LH rear combination lamp. Stop / Tail / Directional Indicator / Fog / Reverse. Horizontal fitting with silver bezel. Suitable for right hand applications.</p> <p>- - -</p> <p>Overall Dimensions : 397mm (L) x 165mm (H) x 65mm (D)</p> <table border="0"> <tr> <td>Voltage</td> <td>Side</td> <td>Function</td> <td>Spare Lens</td> </tr> <tr> <td>N/a.</td> <td>RH</td> <td>5</td> <td>Centre 343/22 & Red : 343/40</td> </tr> </table>	Voltage	Side	Function	Spare Lens	N/a.	RH	5	Centre 343/22 & Red : 343/40	BMA343HRFS	 LEMAC
Voltage	Side	Function	Spare Lens									
N/a.	RH	5	Centre 343/22 & Red : 343/40									
	Fly Leads	<p>LH Rear Combination Lamp > Universal Applications LH rear combination lamp. Stop / Tail / Directional Indicator / Fog / Reverse. Horizontal fitting with silver bezel. Suitable for left hand applications.</p> <p>- - -</p> <p>Overall Dimensions : 397mm (L) x 165mm (H) x 65mm (D)</p> <table border="0"> <tr> <td>Voltage</td> <td>Side</td> <td>Function</td> <td>Spare Lens</td> </tr> <tr> <td>N/a.</td> <td>LH</td> <td>5</td> <td>Centre 343/22 & Red : 343/40</td> </tr> </table>	Voltage	Side	Function	Spare Lens	N/a.	LH	5	Centre 343/22 & Red : 343/40	BMA343HLFS	 LEMAC
Voltage	Side	Function	Spare Lens									
N/a.	LH	5	Centre 343/22 & Red : 343/40									
		<p>Rear Combination Lens > Universal Applications Centre rear combination lens. Directional Indicator / Reverse / Reflex Reflector. To suit both horizontal and vertical 343 lamps.</p> <p>- - -</p> <table border="0"> <tr> <td>Side</td> <td>Mount</td> <td>Fits Lamps</td> </tr> <tr> <td>N/a.</td> <td>Horizontal or Vertical</td> <td>343 Range of lamps</td> </tr> </table>	Side	Mount	Fits Lamps	N/a.	Horizontal or Vertical	343 Range of lamps	BMA343/22	 LEMAC		
Side	Mount	Fits Lamps										
N/a.	Horizontal or Vertical	343 Range of lamps										
		<p>Rear Lens > Universal Applications Red rear lens. To suit vertical mount 343 lamps.</p> <p>- - -</p> <table border="0"> <tr> <td>Side</td> <td>Mount</td> <td>Fits Lamps</td> </tr> <tr> <td>N/a.</td> <td>Vertical</td> <td>343VRFS & 343VLFS</td> </tr> </table>	Side	Mount	Fits Lamps	N/a.	Vertical	343VRFS & 343VLFS	BMA343/30	 LEMAC		
Side	Mount	Fits Lamps										
N/a.	Vertical	343VRFS & 343VLFS										
		<p>Rear Lens > Universal Applications Red rear lens. To suit horizontal mount 343 lamps.</p> <p>- - -</p> <table border="0"> <tr> <td>Side</td> <td>Mount</td> <td>Fits Lamps</td> </tr> <tr> <td>N/a.</td> <td>Horizontal</td> <td>343HRFS & 343HLFS</td> </tr> </table>	Side	Mount	Fits Lamps	N/a.	Horizontal	343HRFS & 343HLFS	BMA343/40	 LEMAC		
Side	Mount	Fits Lamps										
N/a.	Horizontal	343HRFS & 343HLFS										
	LED	<p>LED Stop / Tail / Indicator Lamp > Universal Applications 24V Stop / Tail / Indicator Lamp with red & amber reflectors. Stop & Tail functions are positioned in the lower half of the lamp. Complete with flying leads. Features 42 LEDs. E Approved.</p> <p>- - -</p> <p>Overall Dimensions : 135mm (Dia)</p> <table border="0"> <tr> <td>Voltage</td> <td>LED</td> </tr> <tr> <td>24v</td> <td>Yes</td> </tr> </table>	Voltage	LED	24v	Yes	BMA373AR	 LEMAC				
Voltage	LED											
24v	Yes											
	LED	<p>LED Stop / Tail / Indicator Lamp > Universal Applications 24V Stop / Tail / Indicator Lamp with silver reflectors. Stop & Tail functions are positioned in the lower half of the lamp. Complete with flying leads. Features 42 LEDs. E Approved.</p> <p>- - -</p> <p>Overall Dimensions : 135mm (Dia)</p> <table border="0"> <tr> <td>Voltage</td> <td>LED</td> </tr> <tr> <td>24v</td> <td>Yes</td> </tr> </table>	Voltage	LED	24v	Yes	BMA373SS	 LEMAC				
Voltage	LED											
24v	Yes											
	LED	<p>LED Fog Lamp > Universal Applications 24V Fog Lamp with silver reflectors. Stop & Tail functions are positioned in the lower half of the lamp. Complete with flying leads. Features 42 LEDs. E Approved.</p> <p>- - -</p> <p>Overall Dimensions : 135mm (Dia)</p> <table border="0"> <tr> <td>Voltage</td> <td>LED</td> </tr> <tr> <td>24v</td> <td>Yes</td> </tr> </table>	Voltage	LED	24v	Yes	BMA377S	 LEMAC				
Voltage	LED											
24v	Yes											
5.12	B&C	Website : www.bowersmidland.co.uk	Bowers	5.12								

Bmac Products

Range of Lighting Products



Bmac Lighting



Single Function Lamps



Combination Lamps



Marker Lamps

Did you know that we supply Bmac Products?

Full Range Available

Rear Lamps, LED Lighting, Mounts, Etc

Many Popular Ranges

Contact our sales team for with your enquiry

Tel : 01782 590700 or Fax : 01782 590712

sales@bowersmidland.co.uk

Switches / Large	Part Number	Description	Switches
	<p style="text-align: center;">1831D914</p>	<p>24V Battery Isolator Switch - Marine Applications A manually operated rotary action battery cut-off switch with self aligning main contacts. Aux contacts open in advance of main contacts. Splashproof construction. It is not intended that the switch should be used to break heavy current loads. Except in an emergency such as a complete short circuit.</p> <p>Main contacts : <i>Continuous rated at 200amps.</i> Main contacts : <i>Intermittent rated at 1200amps.</i></p> <p>Aux contacts : <i>24v application rated at 4amps.</i></p> <p style="text-align: center;">** SERVICE EXCHANGE PART, OLD CORE REQUIRED **</p>	
	<p style="text-align: center;">922-B33-K75-5-S12</p>	<p>24V Battery Isolator Switch - Various Applications Suitable for all types of vehicles inc. tankers, boats & battery powered vehicles. Double pole isolation switch with toggle action. A version for use in hazardous areas, (Petroleum and chemical tankers etc) is available to special order. Operating temperature range -40°C to +75°C.</p> <p>Main contacts : <i>Current rating range 120amps.</i> Aux contacts : <i>24v application rated at 6amps.</i></p> <p>Aux contacts : <i>110v application rated at 1amp.</i></p>	
	<p style="text-align: center;">9996060</p>	<p>24V Battery Isolator Switch - Various Applications Suitable for vehicles carrying dangerous goods i.e. petroleum, gases, etc. Double pole isolation switch. ADR European guideline requires the installation of a battery switch capable of being operated and reset from the drivers position. This switch provides electronically controlled operations to meet this requirement. Housing rated to IP65. Not a fire hazard in explosive atmospheres.</p> <p>Continuous : <i>24v application rated at 120amps.</i> Intermittent : <i>1 sec at 23°C rated at 1500amps.</i></p>	
	<p style="text-align: center;">9996061</p>	<p>24V Battery Isolator Switch - Various Applications Suitable for vehicles carrying dangerous goods i.e. petroleum, gases, etc. Double pole isolation switch with independent D+ aux circuit. ADR European guideline requires the installation of a battery switch capable of being operated and reset from the drivers position. This switch provides manual and pneumatic controlled operations to meet this requirement. Housing rated to IP65. Not a fire hazard in explosive atmospheres.</p>	
	<p style="text-align: center;">9996064</p>	<p>Continuous : <i>24v application rated at 250amps.</i> Intermittent : <i>5 sec max at 23°C rated at 2500amps.</i></p> <p>Air Distributor : 9996064 <i>2 Positively interlocked positions : Battery switch + engine stop. Setting in cab.</i></p>	
<p style="text-align: center;">6.1</p>	<p style="text-align: center;">Tel : 01782 590700</p>	<p style="text-align: center;">Bus & Coach Products Catalogue</p>	<p style="text-align: center;">6.1</p>

Switches	Description	Part Number	Switches
	<p>24V Battery Isolator Switch - Various Applications Suitable for vehicles carrying dangerous goods i.e. petroleum, gases, etc. ADR Compliant for transportation of hazardous goods. Relay, control electronics and power supply for tachograph in a compact housing. Suitable for single and double pole applications. Integral low voltage monitoring to prevent total discharge of the battery. Operated by a control switch in the drivers cab.</p> <p>Seperate information sheet available upon request</p>	<p>9996077</p>	
	<p>24V Battery Isolator Switch - Universal Applications 2 Pole isolator switch. Reinforced PBT withstanding rough environments. Silver plated copper connection studs. Aux circuit 1 (Alternator) : Switches immediately after the control switch is operated then the main circuits open after less than 30ms delay. Aux circuit 2 (ECM) : Switches off after a 10sec delay when main circuits are open.</p> <p>Continuous : <i>Rated at 300amps.</i> Intermittent : <i>5 sec rated at 2500amps.</i></p> <p>See `Appendix A` for wiring diagram, (Page 4.3).</p>	<p>9996081</p>	 
	<p>24V Genuine Lucas Battery Isolator Switch Specially designed for commercial vehicles. Fully sealed heavy duty master switch. Essential for vehicles carrying dangerous loads i.e. petroleum products, gases, acids, etc. Resistant to salty spray & chemical attack. Manufactured from self extinguishing material. Solenoid operating voltage 12-31v. Operating temp. range -40°C to +80°C.</p> <p>Main contacts : <i>Normal current load 150amps.</i> Main contacts : <i>Make & break current load 2500amps.</i></p> <p>Aux contacts : <i>15amps.</i></p> <p>Delay between main & aux contacts opening (Solenoid operation only) : <i>0.02 - 0.03 seconds</i></p> <p>** SERVICE EXCHANGE PART, OLD CORE REQUIRED **</p>	<p>SSB100</p>	 
	<p>CAV Battery Isolator Switch ...</p> <p>** SERVICE EXCHANGE PART, OLD CORE REQUIRED **</p>	<p>134 17</p>	 
6.2	Bus & Coach Products Catalogue	Fax : 01782 590712	6.2

WIRING DIAGRAM FOR 9996081 BATTERY ISOLATOR SWITCH

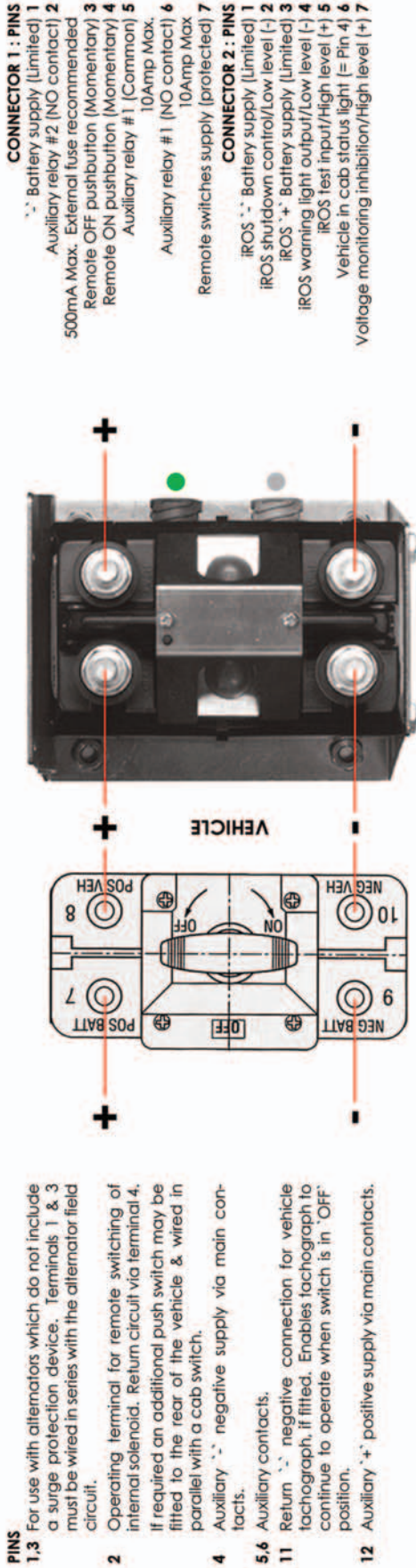

DETAILED VIEWS

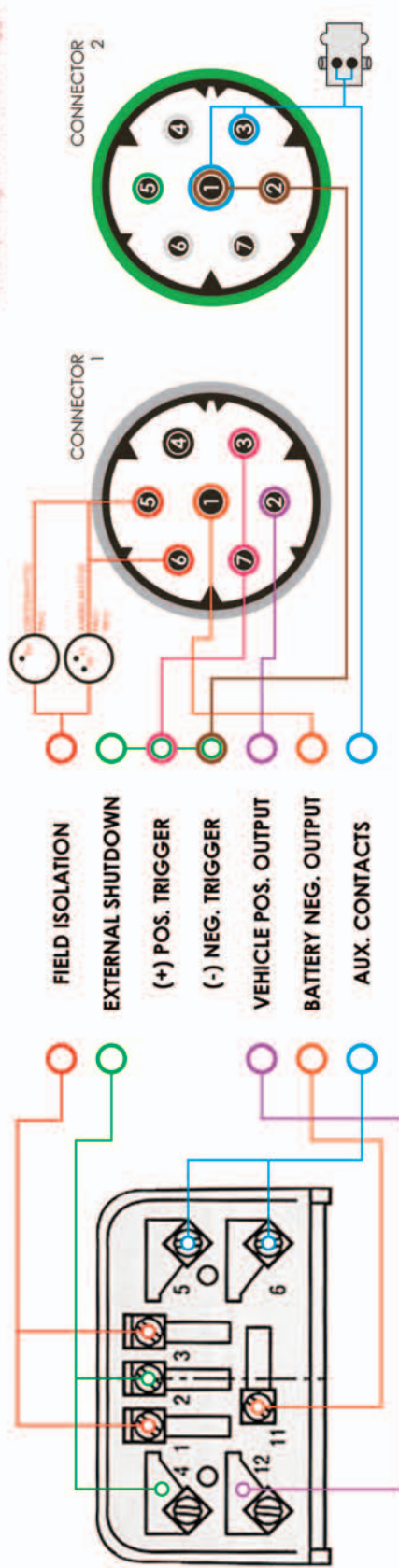

This is a positive vehicle output, the same as the Lucas SS8 Master Switch except that it is a current limited to 1 amp. It also has a 10 second delay when the master switch is turned off via the external shutdown on connector 1 or on the master switch itself.

AUX. CONTACTS VIA ACTUATED RELAY
Pins 1 & 2 on connector 1 can also perform this operation

Bowers Website

www.bowersmidland.co.uk



Home Page

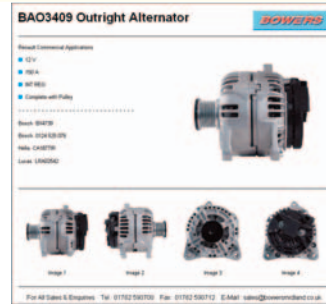

New Stock Features











Product Details



Bowers Information

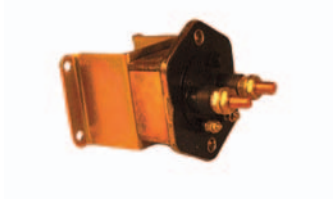

Want to stay up to date?
New Stock, Offers, Catalogues
 All our latest catalogue updates and current offers
www.bowersmidland.co.uk
 No log-in required - Browse our website today







Read our history, find data sheets
 See featured products and much more





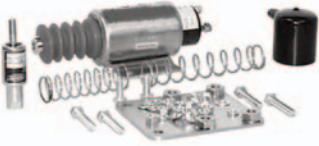

Switches / Standard	Part Number	Description	Switches
	9996000 Spare Key : 9996000K	12/24V Battery Isolator Switch - Universal Supplied with detachable key. Complete with dust cover on switch. Continuous : Rated at 100amps. Intermittent : Rated at 500amps.	
	9996001 Spare Key : 9996001K	12/24V Battery Isolator Switch - Universal Supplied with detachable key & chain. Complete with dust cover on switch and key. Continuous : Rated at 250amps. Intermittent : Rated at 2500amps.	
	9996030 Spare Key : 9996030K	12/24V Battery Isolator Switch - Universal Supplied with detachable key. Complete with dust cover on switch. When turned to the 'OFF' position the engine will be automatically stopped due to the secondary switch function whereby the ignition circuit is cut. This prevents engine 'run-on' and is a vital safety feature. Continuous : Rated at 100amps. Intermittent : 5 sec rated at 500amps.	
	9996031	12/24V Battery Isolator Switch - Various Suitable for cars, light commercial & light industrial applications. Panel mounted rotary switch. Equivalent to Lucas SSB106. Fixing - 19mm (Dia) hole size. Continuous : 12v application rated at 100amps.	
	9996063	24V Electromagnetic Battery Isolator Switch - Volvo Electromagnetic battery isolator switch/relay. Remotely operated. Suitable for alternators with incorporated controller unit. Continuous : Rated at 500amps. Intermittent : Rated at 2500amps.	
	9996065	24V Electromagnetic Battery Isolator Switch - Volvo Electromagnetic battery isolator switch/relay. Remotely operated. Suitable for alternators with incorporated controller unit. Continuous : Rated at 500amps. Intermittent : Rated at 2500amps.	
	9996066	Battery Isolator Switch - Universal With key control. Fixing - 31mm (Dia) hole size. Continuous : Rated at 85amps. Intermittent : 5 sec max rated at 300amps.	
	9996067	Battery Isolator Switch - Universal Single pole isolator switch with removable handle. Fixing - 24mm (Dia) hole size. Continuous : Rated at 150amps. Intermittent : 5 sec max rated at 1000amps.	
6.5	Tel : 01782 590700	Bus & Coach Products Catalogue	6.5

Switches	Description	Part Number	Switches / Standard
	<p>Battery Isolator Switch - Universal Chrome plated single pole isolator switch. Protection to IP43. Key operated. Supplied with 2 keys. Continuous : Rated at 150amps. Intermittent : 5 sec max rated at 1000amps.</p>	<p>9996072</p>	
	<p>Battery Isolator Switch - Universal Single pole isolator switch with fixed red thermoplastic handle. Black body finishing. Continuous : Rated at 250amps. Intermittent : 5 sec max rated at 2000amps.</p>	<p>9996073</p>	 
	<p>Battery Isolator Switch - Universal Single pole isolator switch with fixed red metallic handle. Manual control. Fixing - 31mm (Dia) hole size. Continuous : Rated at 250amps. Intermittent : 5 sec max rated at 1000amps.</p>	<p>9996080</p>	 
6.6	Bus & Coach Products Catalogue	Fax : 01782 590712	6.6

Air Heaters		Product Image		Notes / Applications	Heaters
D2 Airtronic		 		<i>See website for full details.</i> Diesel or paraffin	Model
12 / 24 V	2.7 Kg				2.0 Kg
Eberspacher	Air Heater				Water Heater
D4 Airtronic		 		<i>See website for full details.</i> Diesel or paraffin	
12 / 24 V	4.5 Kg				
Eberspacher	Air Heater				
D5 Airtronic		 		<i>See website for full details.</i> Diesel or paraffin	
12 / 24 V	8.0 Kg				
Eberspacher	Air Heater				
D8LC		 		<i>See website for full details.</i> Diesel or paraffin	
12 / 24 V	20.0 Kg				
Eberspacher	Air Heater				
V7S		 		<i>See website for full details.</i> Diesel or paraffin	
24 V	14.0 Kg				
Eberspacher	Air Heater				
Airtop 2000		 		<i>See website for full details.</i> Diesel or paraffin, petrol	
12 / 24 V	2.6 Kg				
Webasto	Air Heater				
Airtop 3500 / 5000		 		<i>See website for full details.</i> Diesel	
12 / 24 V	2.7 Kg				
Webasto	Air Heater				
7.1		Order Hotline : 01782 590700		Bus & Coach	7.1

Heaters	Notes / Applications	Product Image		Water Heaters	
Model	See website for full details.			Hydronic 4	
12 V	Diesel or paraffin			12 V	2.9 Kg
Eberspächer				Eberspächer	Water Heater
	See website for full details.			Hydronic 5	
	Diesel or paraffin			12 / 24 V	2.9 Kg
				Eberspächer	Water Heater
	See website for full details.			Hydronic 10	
	Diesel or paraffin			12 / 24 V	6.9 Kg
				Eberspächer	Water Heater
	See website for full details.			Hydronic 16 / 24	
	Diesel or paraffin			24 V	18.0 Kg
				Eberspächer	Water Heater
	See website for full details.			Hydronic 30 / 35	
	Diesel or paraffin			24 V	18.0 Kg
				Eberspächer	Water Heater
	See website for full details.			Thermo 230 / 300	
	Diesel or paraffin			24 V	19.0 Kg
				Webasto	Water Heater
	See website for full details.			Thermo 350	
	Diesel or paraffin			24 V	19.0 Kg
				Webasto	Water Heater
7.2	Bus & Coach	Sales Fax : 01782 590712		7.2	

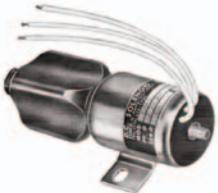
Solenoids	Part Number	Description	Solenoids
	3905000	12V Solenoid - Various Applications Suitable for various applications, pump motors, winch motors, etc. Insulated. Continuously rated. Normally Open. Normally open ratings: Continuous: 80amps, Max per 5 sec: 150amps	
	3905001	24V Solenoid - Various Applications Suitable for various applications, pump motors, winch motors, etc. Insulated. Continuously rated. Normally Open. Normally open ratings: Continuous: 60amps, Max per 5 sec: 100amps	
	3905002	36V Solenoid - Various Applications Suitable for various applications, pump motors, winch motors, etc. Insulated. Continuously rated. Normally Open. Normally open ratings: Continuous: 50amps, Max per 5 sec: 100amps	
	3905003	12V Solenoid - Various Applications Suitable for various applications, pump motors, winch motors, etc. Insulated. Continuously rated. Changeover contacts, (1 Set normally open, 1 set normally closed). Can be used in conjunction with reversible motors. Normally open ratings: Normally closed ratings: Continuous: 80amps, Continuous: 50amps, Max per 5 sec: 150amps Max per 5 sec: 60amps	
	3905004	24V Solenoid - Various Applications Suitable for various applications, pump motors, winch motors, etc. Insulated. Continuously rated. Changeover contacts, (1 Set normally open, 1 set normally closed). Can be used in conjunction with reversible motors. Normally open ratings: Normally closed ratings: Continuous: 60amps, Continuous: 30amps, Max per 5 sec: 50amps Max per 5 sec: 30amps	
	3905007	24V Engine Stop Solenoid - Universal Applications Pull type operation. Full kit of parts for complete installation.	
	3905008	12V Engine Stop Solenoid - Universal Applications Pull type operation.	
	3905009	12V Engine Stop Solenoid - Universal Applications Pull type operation.	

Solenoids	Description	Part Number	Solenoids
	24V Engine Stop Solenoid - Universal Applications Push type operation.	3905010	
	24V Engine Stop Solenoid - Universal Applications Pull type operation.	3905011	
	24V Engine Stop Solenoid - Universal Applications Pull type operation.	3905012	
	24V Engine Stop Solenoid - Universal Applications -	3905013	
	24V Engine Stop Solenoid - Universal Applications Pull type operation. No fitting kit supplied.	3905014	
	24V Engine Stop Solenoid - Universal Applications Push type operation. No fitting kit supplied. Push Current: 30amps Hold Current: 8amps	3905015	
	12V Engine Stop Solenoid - Universal Applications Pull type operation. No fitting kit supplied.	3905016	
	24V Engine Stop Solenoid - Universal Applications Pull type operation. No fitting kit supplied. Push Current: 43amps Hold Current: 6amps	3905017	

Solenoids	Part Number	Description	Solenoids
	<p>PRE1827631</p>	<p>24V Engine Stop Solenoid - Universal Applications Pull type operation. 4 Screw holes. Type 263A23-24v. Despatch No. 1827631</p> <p>** SERVICE EXCHANGE PART, OLD CORE REQUIRED **</p>	
	<p>PRE1827711</p>	<p>24V Engine Stop Solenoid - Universal Applications Pull type operation. Type 263A31-24v.</p> <p>** SERVICE EXCHANGE PART, OLD CORE REQUIRED **</p>	
 <p>Image Unavailable</p>	<p>PRE1827771</p>	<p>Engine Stop Solenoid - Universal Applications -</p> <p>** SERVICE EXCHANGE PART, OLD CORE REQUIRED **</p>	
	<p>PRE1827781</p>	<p>24V Engine Stop Solenoid - Universal Applications Pull type operation. 4Screw holes. Type 263A-38.</p> <p>** SERVICE EXCHANGE PART, OLD CORE REQUIRED **</p>	
	<p>PRE1830592</p>	<p>24V CAV Engine Stop Solenoid - Uni Applications Push type operation. 4 Screw holes. CAV Solenoid. Type 368-9B. Despatch No. 1830592.</p> <p>** SERVICE EXCHANGE PART, OLD CORE REQUIRED **</p>	
<p>8.3</p>	<p>Tel : 01782 590700</p>	<p>Bus & Coach Products Catalogue</p>	<p>8.3</p>

Catalogue Range

The Bowers range of product catalogues



Lighting Products



Rotating Electrics



Ancillary Products



Bus & Coach

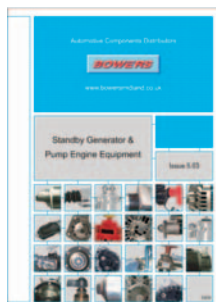

Standby Generator



Specialised Rotating



Product Directory

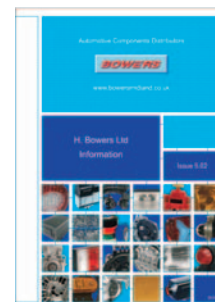

Bowers Information

Do you have the latest issue catalogues?

Get your copy NOW

Your quickest route to our most up-to-date versions is at

www.bowersmidland.co.uk

Or request a hard copy catalogue from our sales team

Tel : 01782 590700 Fax : 01782 590712

E-Mail : sales@bowersmidland.co.uk

Accessories	Part Number	Description	Accessories
	1050030	24V Wiper Motor - Double Speed For Truck - Bus Speed Level I 2.0A, 18W, 27RPM Speed Level II 2.5A, 20W, 32RPM Torque Continuous 6Nm, Breakaway 30Nm Rotation Clockwise Type of Duty S1 Protection IP33 Weight 2.750Kg	
	1050031	24V Wiper Motor - Double Speed For Heavy Duty Speed Level I 3.0A, 32W, 20RPM Speed Level II 4.0A, 40W, 35RPM Torque Continuous 15Nm, Breakaway 100Nm Rotation Clockwise Type of Duty S1 Protection IP23 Weight 4.420Kg	
	1060023	24V Medium Size Blower - 4 Speed Voltage 24V	
	1060024	24V Medium Size Blower - 4 Speed Voltage 24V	
	1060026	12V Medium Size Blower - 4 Speed Voltage 12V	
	1060027	12V Medium Size Blower - 4 Speed Voltage 12V	
	1065001	24V Centrifugal Water Pump - Large Type Voltage 24V Speed Level I 3.5A, 250W Pressure 0.2BAR Flow Rate 6000 Lt/H Type of Duty S1 Weight 4.90Kg	
	1065002	24V Centrifugal Water Pump Voltage 24V Speed Level I 2.5A, 100W Pressure 0.2BAR Flow Rate 4500 Lt/H Type of Duty S1 Weight 1.890Kg	
9.1	Tel : 01782 590700	Bus & Coach Products Catalogue	9.1

Accessories	Description	Part Number	Accessories
	24V Centrifugal Water Pump - Small Type Voltage 24V Speed Level I 2.0A, 40W Pressure 0.2BAR Flow Rate 1250 Lt/H Type of Duty S1 Weight 1.520Kg	1065003	
	12V Heater Unit - Single Voltage 12V Heat Capacity 4000kcal/h Overall Length 262mm Overall Width 193mm Overall Height 197mm	1066003	
	24V Heater Unit - Single Voltage 24V Heat Capacity 4000kcal/h Overall Length 262mm Overall Width 193mm Overall Height 197mm	1066004	
	24V Bus Vacuum ... ** REPAIR ONLY **	Bus Vacuum	
9.2	Bus & Coach Products Catalogue	Fax : 01782 590712	9.2

Workshop Service & Repair Facility

More than just an automotive components distributors

Air Conditioning Units / Heater Systems

Our fully trained workshop technicians have vast experience working with both Eberspacher and Webasto equipment.

Rotating Electrics

Can't source a unit? Or is it too expensive to buy? Let our trained staff repair your old unit. We have the knowledge & experience to help.

Shown on this page are images of equipment that we regularly carry out work on



Sales Tel : 01782 590700

Sales Fax : 01782 590712

sales@bowersmidland.co.uk

www.bowersmidland.co.uk

Workshop Contacts

Workshop Telephone : **01782 590702**

Workshop Fax : **01782 598516**

Ian Simpson

Service Manager & Technical Enquiries

Doug Roberts

Bowers Auto-Electrician

Bob Boughey

Bowers Auto-Electrician



